

**Honeywell**

---

**Honeywell Process Solutions**

**Isolated Analog Output Module  
2MLF-DV4S, 2MLF-DC4S  
User's Guide**

ML200-IAO  
R200  
September 2010

**Release 200**

**Honeywell**

## Notices and Trademarks

**Copyright 2010 by Honeywell International Sarl.  
Release 200 September, 2010**

While this information is presented in good faith and believed to be accurate, Honeywell disclaims the implied warranties of merchantability and fitness for a particular purpose and makes no express warranties except as may be stated in its written agreement with and for its customers.

In no event is Honeywell liable to anyone for any indirect, special or consequential damages. The information and specifications in this document are subject to change without notice.

Honeywell, PlantScape, Experion PKS, and **TotalPlant** are registered trademarks of Honeywell International Inc.

Other brand or product names are trademarks of their respective owners.

Honeywell Process Solutions  
1860 W. Rose Garden Lane  
Phoenix, AZ 85027 USA  
**1-800 822-7673**

## About This Document

This document describes how to install and configure the 2MLF-DV4S, 2MLF-DC4S isolated analog output modules.

### Release Information

Document Name	Document ID	Release Number	Publication Date
2MLF-DV4S, 2MLF-DC4S User's Guide	ML200-IAO	200	September 2010

### References

The following list identifies all documents that may be source of reference for material discussed in this publication.

Document Title
SoftMaster User's Guide

### Contacts

#### World Wide Web

The following Honeywell web sites may be of interest to Process Solution customers.

Honeywell Organization	WWW Address (URL)
Corporate	<a href="http://www.honeywell.com">http://www.honeywell.com</a>
Process Solutions	<a href="http://www.honeywell.com/ps">http://www.honeywell.com/ps</a>

## Acronyms and definitions

Acronym/Term	Definition
A/D converter	Converts analog to digital value.
Analog input module	This module converts analog voltage/current input to digital value. It has a resolution of 14 and 16 bits.
Channel	Related with the terminal of analog I/O module and connected to various voltage/current I/O devices, respectively, with applicable data and diagnosis function.
Conversion time	Time taken by an analog input module to sample and convert the analog signal to digital value. Also, it refers to the time taken by an analog output module to convert a digital value to analog value.
D/A converter	Related with the output module, it is used to make continuous size of analog voltage and current signal proportionately to the digital value.
Full scale	Defined as the size of voltage/current where the normal operation is executed.
Full scale error	Displays the graph difference between agreeable analog-converted value and actual analog-converted value.
Full scale range	Displays the difference between the maximum and the minimum of the analog input.
LSB	Least significant bit (LSB) displays the minimum value of the bit unit.

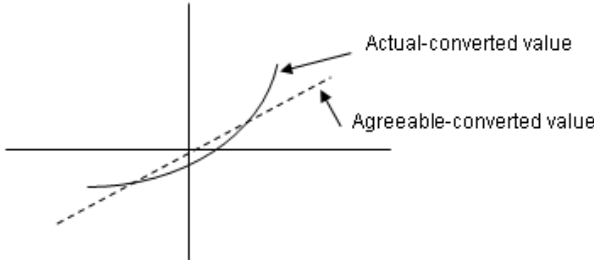
Acronym/Term	Definition
Linearity error	<p>Analog I/O is related between continuous voltage/current value and digital value, whose agreeable I/O value is defined as a line within a distance of the minimum 1LSB of voltage/current. I/O linearity error is regarded as the declination between the agreeable-converted value and the actual-converted value on the graph.</p> 
Multiplexer	<p>A switching circuit where many signals share one A/D converter or D/A converter.</p>
Analog output module	<p>A module with an output circuit to convert analog DC voltage or current signal proportionate to digital value delivered to the module from the processor.</p>
Resolution	<p>The minimum value recognizable by a measuring instrument, which is usually displayed in engineering units (1mV) or the number of bits. In other words, 16383 types of output are available for 14 bits.</p>
Filter	<p>Used to reduce the change in digitally-converted value by sudden change in the external noise or input for the analog circuit, through Software and Hardware filters.</p>
Accuracy	<p>Displays the maximum declination between agreeable value and output voltage or current for the whole range of output. On the other hand, it displays the maximum declination between agreeable value and digitally-converted input signal value for the whole range of input. Generally, percentage is displayed for the full scale. Gain, Offset and Linearity error are all included in the error type available.</p>
Output accuracy	<p>Displays the difference between the actual analog output voltage/current value and the agreeable-converted value on the conversion graph for the full scale, with Offset, Gain and Drift error factors included as well as normal temperature (25°) and available temperature range displayed, respectively.</p>

Acronyms and definitions

---

## Support and Other Contacts

### United States and Canada

Contact: Honeywell Solution Support Center  
Phone: 1-800-822-7673  
Calls are answered by dispatcher between 6:00 am and 4:00 pm Mountain Standard Time. Emergency calls outside normal working hours are received by an answering service and returned within one hour.  
Fascimile: 1-973-455-5000  
Mail: Honeywell TAC, MS L17  
1860 W. Garden Lane  
Phoenix, AZ, 85027 USA

### Europe, Middle East, and Africa (EMEA)

Contact: Honeywell TAC-EMEA  
Phone: +32-2-728-2345  
Fascimile: +32-2-728-2696  
Mail: TAC-BE02  
Hermes Plaza  
Hermeslaan, 1H  
B-1831 Diegem, Belgium

### Pacific

Contact: Honeywell Global TAC – Pacific  
Phone: 1300-364-822 (toll free within Australia)  
+61-8-9362-9559 (outside Australia)  
Fascimile: +61-8-9362-9564  
Mail: Honeywell Limited Australia  
5 Kitchener Way  
Burswood 6100, Western Australia  
Email: GTAC@honeywell.com

### India

Contact: Honeywell Global TAC – India  
Phone: +91-20- 6603-9400  
Fascimile: +91-20- 6603-9800  
Mail: Honeywell Automation India Ltd  
56 and 57, Hadapsar Industrial Estate  
Hadapsar, Pune –411 013, India  
Email: Global-TAC-India@honeywell.com

### Korea

## Support and Other Contacts

---

Contact: Honeywell Global TAC – Korea  
Phone: +82-2-799-6317  
Fascimile: +82-2-792-9015  
Mail: Honeywell Co., Ltd  
4F, Sangam IT Tower  
1590, DMC Sangam-dong, Mapo-gu  
Seoul, 121-836, Korea  
Email: Global-TAC-Korea@honeywell.com

### People's Republic of China

Contact: Honeywell Global TAC – China  
Phone: +86- 21-2219-6888  
800-820-0237  
400-820-0386  
Mail: Honeywell (China) Co., Ltd  
33/F, Tower A, City Center, 100 Zunyi Rd.  
Shanghai 200051, People's Republic of China  
Email: Global-TAC-China@honeywell.com

### Singapore

Contact: Honeywell Global TAC – South East Asia  
Phone: +65-6580-3500  
Fascimile: +65-6580-3501  
+65-6445-3033  
Mail: Honeywell Private Limited  
Honeywell Building  
17, Changi Business Park Central 1  
Singapore 486073  
Email: GTAC-SEA@honeywell.com

### Taiwan

Contact: Honeywell Global TAC – Taiwan  
Phone: +886-7-536-2567  
Fascimile: +886-7-536-2039  
Mail: Honeywell Taiwan Ltd.  
17F-1, No. 260, Jhongshan 2nd Road.  
Cianjhen District  
Kaohsiung, Taiwan, ROC  
Email: Global-TAC-Taiwan@honeywell.com

### Japan

Contact: Honeywell Global TAC – Japan  
Phone: +81-3-6730-7160  
Fascimile: +81-3-6730-7228



Mail: Honeywell Japan Inc.  
New Pier Takeshiba, South Tower Building,  
20th Floor, 1-16-1 Kaigan, Minato-ku,  
Tokyo 105-0022, Japan  
Email: Global-TAC-JapanJA25@honeywell.com

### **Elsewhere**

Call your nearest Honeywell office.

### **World Wide Web**

Honeywell Solution Support Online:

<http://www.honeywell.com/ps>







### **Training Classes**





Honeywell Automation College:

<http://www.automationcollege.com>

## Symbol Definitions

The following table lists the symbols used in this document to denote certain conditions.

Symbol	Definition
	<b>ATTENTION:</b> Identifies information that requires special consideration.
	<b>TIP:</b> Identifies advice or hints for the user, often in terms of performing a task.
	<b>REFERENCE -EXTERNAL:</b> Identifies an additional source of information outside of the book set.
	<b>REFERENCE - INTERNAL:</b> Identifies an additional source of information within the book set.
<b>CAUTION</b>	Indicates a situation which, if not avoided, may result in equipment or work (data) on the system being damaged or lost, or may result in the inability to properly operate the process.
	<b>CAUTION:</b> Indicates a potentially hazardous situation which, if not avoided, may result in minor or moderate injury. It may also be used to alert against unsafe practices.  <b>CAUTION</b> symbol on the equipment refers the user to the product manual for additional information. The symbol appears next to required information in the manual.
	<b>WARNING:</b> Indicates a potentially hazardous situation, which, if not avoided, could result in serious injury or death.  <b>WARNING</b> symbol on the equipment refers the user to the product manual for additional information. The symbol appears next to required information in the manual.
	<b>WARNING, Risk of electrical shock:</b> Potential shock hazard where HAZARDOUS LIVE voltages greater than 30 Vrms, 42.4 Vpeak, or 60 VDC may be accessible.

Symbol	Definition
	<b>ESD HAZARD:</b> Danger of an electro-static discharge to which equipment may be sensitive. Observe precautions for handling electrostatic sensitive devices.
	<b>Protective Earth (PE) terminal:</b> Provided for connection of the protective earth (green or green/yellow) supply system conductor.
	<b>Functional earth terminal:</b> Used for non-safety purposes such as noise immunity improvement.  NOTE: This connection will be bonded to Protective Earth at the source of supply in accordance with national local electrical code requirements.
	<b>Earth Ground:</b> Functional earth connection.  NOTE: This connection will be bonded to Protective Earth at the source of supply in accordance with national and local electrical code requirements.
	<b>Chassis Ground:</b> Identifies a connection to the chassis or frame of the equipment, will be bonded to Protective Earth at the source of supply in accordance with national and local electrical code requirements.

## Symbol Definitions

---

# Contents

<b>1. INTRODUCTION .....</b>	<b>17</b>
<b>1.1 Overview of isolated analog output module .....</b>	<b>17</b>
<b>1.2 Terminology .....</b>	<b>18</b>
Analog quantity – A .....	18
Digital quantity – D .....	19
Characteristics of D/A conversion .....	20
<b>2. SPECIFICATIONS .....</b>	<b>23</b>
<b>2.1 Performance specifications .....</b>	<b>23</b>
<b>2.2 Respective designations and functions .....</b>	<b>26</b>
<b>2.3 Characteristics of I/O conversion .....</b>	<b>28</b>
I/O conversion characteristics .....	28
Characteristic of voltage output .....	28
Characteristics of current output .....	30
Accuracy .....	32
<b>2.4 Main functions .....</b>	<b>34</b>
Output status setting .....	34
Display and diagnosis functions .....	35
<b>2.5 Additional functions .....</b>	<b>37</b>
Output limit setting .....	37
Rate control setting .....	40
<b>3. INSTALLATION AND WIRING .....</b>	<b>43</b>
<b>3.1 Before you begin .....</b>	<b>43</b>
Safety instructions .....	43
Safety instructions when designing .....	43
Safety instructions when wiring .....	44
Safety instructions for test-operation or repair .....	45
Safety instructions for waste disposal .....	46
<b>3.2 Installation .....</b>	<b>46</b>
Installation environment .....	46
Precautions for handling .....	47
<b>3.3 Wiring .....</b>	<b>47</b>

## Contents

---

Wiring precautions.....	47
Wiring examples.....	48
<b>3.4 Wiring of DC 24V.....</b>	<b>50</b>
Specification of power supply.....	50
Using an external power module.....	51
<b>4. OPERATIONS AND MONITORING .....</b>	<b>53</b>
<b>4.1 Operations.....</b>	<b>53</b>
<b>4.2 Configuring parameters .....</b>	<b>54</b>
Setting items.....	54
Using I/O parameters .....	55
<b>4.3 Parameter configuration .....</b>	<b>56</b>
Configuring parameters.....	56
<b>4.4 Monitoring or testing.....</b>	<b>67</b>
Monitoring or testing window.....	67
Programmatic operation of the module .....	72
<b>4.5 Register special module variables.....</b>	<b>73</b>
Registering special module variables.....	73
Saving variables.....	75
View variables .....	75
<b>5. INTERNAL MEMORY CONFIGURATION.....</b>	<b>79</b>
<b>5.1 Configuring internal memory .....</b>	<b>79</b>
I/O area of D/A converted data.....	79
Setting area of operation parameters.....	81
<b>5.2 I/O area of D/A converted data .....</b>	<b>83</b>
Module ready/error (Address 0).....	83
Channel operation information (Address 1).....	84
Output setting (Address 2) .....	84
Digital input (Address 3~6).....	84
<b>5.3 Operation parameters settings .....</b>	<b>86</b>
Specifying channels to use.....	86
Setting output voltage/current range .....	86
Specifying input data type .....	87
Setting output type .....	88
Error code .....	88
Output limit setting.....	90
CH0 high output limit setting .....	90
Rate control setting .....	91
CH0 increase limit value setting .....	91

<b>6. PROGRAMMING</b>	<b>93</b>
6.1 Internal memory read/write	93
Reading internal memory (GET, GETP instruction)	93
Write of internal memory (PUT, PUTP instruction)	94
6.2 Basic program	96
2MLF-DC4S	96
6.3 Application program	99
Inverter speed control	99
BCD output of error code	102
 <b>7. TROUBLESHOOTING</b>	 <b>107</b>
7.1 Diagnosing errors	107
Error codes	107
7.2 Diagnosis of errors	110
RUN LED blinks	110
RUN LED is Off	111
D/A output value hunted too much	112
Relationship discordant between digital value and analog output value	113
D/A output value always exceeds the value specified	114
Analog output value does not change according to the change of digital value	115
Hardware error of D/A conversion module	115
Status check of D/A conversion module through SoftMaster system monitoring	116
 <b>8. APPENDIX 1</b>	 <b>119</b>
8.1 Dimensions of 2MLF-DV4S/DC4S	119

## Contents

---



# 1. Introduction

## 1.1 Overview of isolated analog output module

The isolated D/A conversion module is used to convert the digital value of signed 16-bit binary data (data: 14 bits) specified in PLC CPU to analog signal (voltage or current output).

Voltage output is called as 2MLF-DV4S and current output as 2MLF-DC4S in this product.

Features of isolated analog output module are as follows:

1. D/A conversion of four channels:
  - 2MLF-DV4S:** D/A conversion of four channels (voltage output)
  - 2MLF-DC4S:** D/A conversion of four channels (current output)
2. Isolation between channels: The data between channels is processed with high-reliability.
3. High resolution of 1/16000: Offers a high resolution analog value through the digital value resolution of 1/16000.
4. High accuracy: High accuracy of  $\pm 0.1\%$  or less (when ambient temperature is 25°).
5. Various output range available are:
  - a) **2MLF-DV4S:** 1~5V, 0~5V, 0~10V, -10~10V
  - b) **2MLF-DC4S:** 4~20mA, 0~20mA
6. Output limit setting: Allows the limiting of the digital value range.
7. Rate control setting: Enables the setting of rate or digital value.
8. No limit on the number of modules used on one base: Any number of modules within the capacity of the power module can be installed on a base.

## 1.2 Terminology

### Analog quantity – A

The following figures depict the conversion of temperature to an analog value of DC voltage, using a transducer.

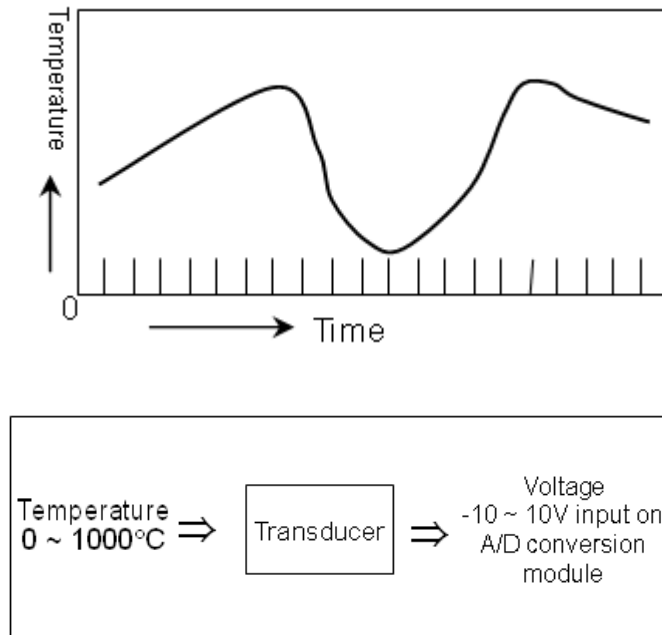

Such analog value conversions can be voltage, current, temperature, speed, pressure, and flow. For example, temperature may continuously change over time as shown in the figure. Since the changing temperature cannot be directly fed to the PLC, it must be fed to the PLC by converting to identical analog quantity of DC voltage – 10 ~+10V or current 4~20mA using a transducer.

### Digital quantity – D

The following figure displays the digital value.

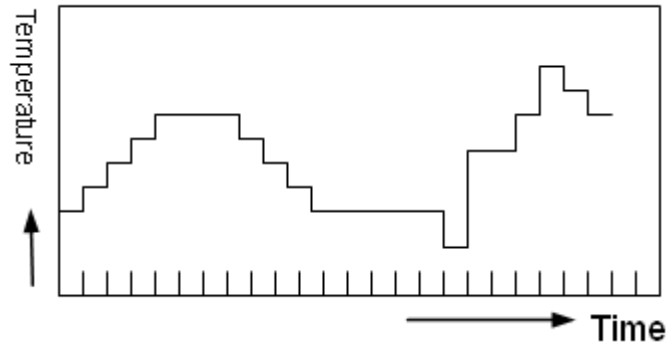

A discontinuously changing value is called digital value. The figure displays a digital value. For example, the digital quantity of 0 and 1 displays On and Off signal. Binary coded decimal (BCD) and binary value is also a digital value.

This figure displays the process in the PLC.

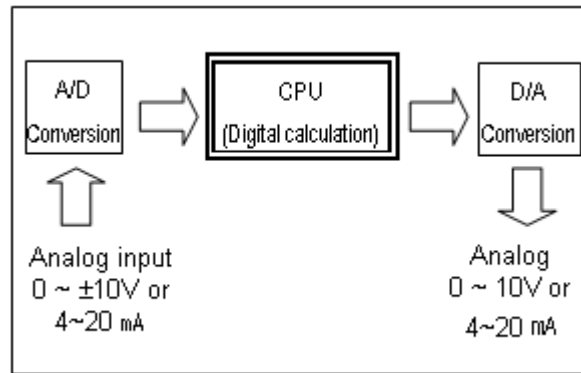

Analog value cannot be directly fed to the PLC CPU for calculation of the digital value. The analog value is converted to digital value as in the figure and fed to the CPU. In addition, in order to output the analog value outward, the CPU's digital value is converted to analog value.

**1. Introduction**  
**1.2. Terminology**

---

**Characteristics of D/A conversion**

1. Voltage output

The following figure illustrates the characteristic of the D/A conversion (voltage output).

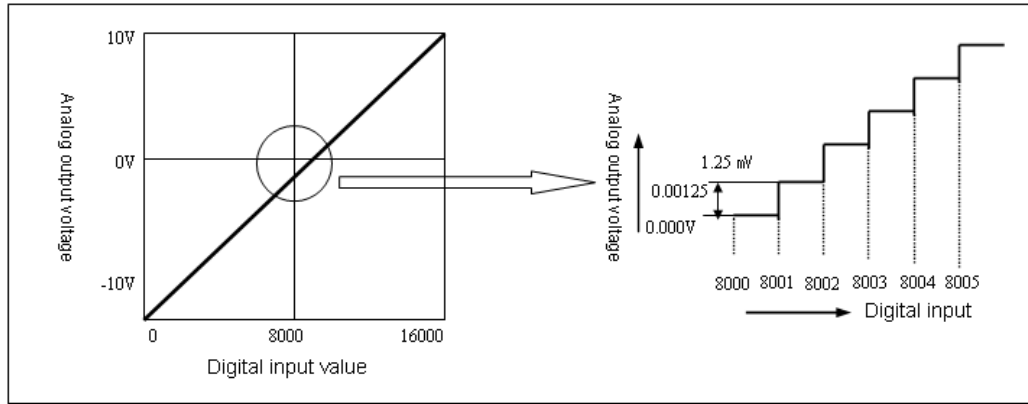

The D/A conversion module is used to convert a digital value from CPU to analog value for an external device. When the voltage output range of D/A conversion module is -10~10V, and the input digital value is 0, the output is -10V. If the digital input is 16000, the output is 10V, where analog value converted from digital input of 1 is equivalent to 1.25mV.

Current output

The following figure illustrates the characteristic of the D/A conversion (current output).

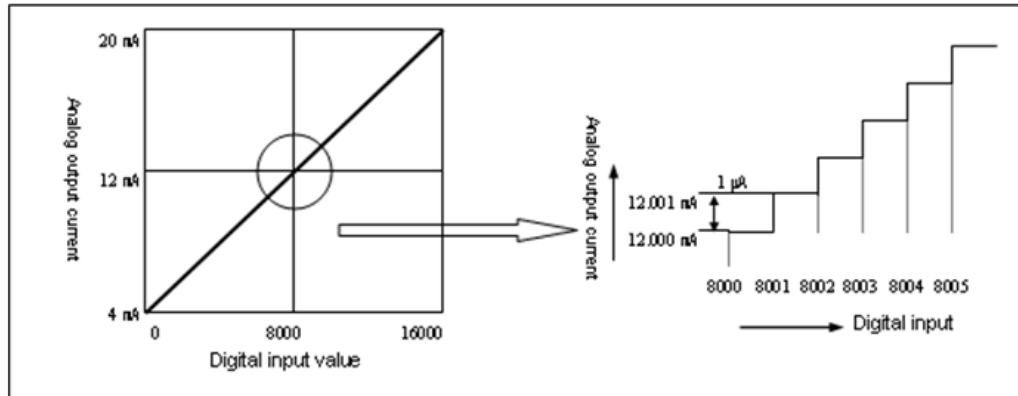

When the current output range of the D/A conversion module is 4~20mA, the output is 4mA if the digital input is 0. The output is 20mA if the digital input is 16000, where analog value converted from digital input of 1 is equivalent to 1μA.

**1. Introduction**  
1.2. Terminology

---

## 2. Specifications

### 2.1 Performance specifications

The following table specifies the performance specifications of the D/A conversion module.

Item	Specification		
	<i>2MLF-DV4S (Isolated Voltage Output Type)</i>	<i>2MLF-DC4S (Isolated Current Output Type)</i>	
Analog output	DC 1 ~ 5V	DC 4 ~ 20mA } Load resistance: 600Ω or less	
	DC 0 ~ 5V		DC 0 ~ 20mA
	DC 0 ~ 10V		
	DC -10 ~ 10V		

Select the output range through an applicable program or parameters (for respective channels).

Signed 16-bit binary value (data: 14 bits)

Set the format of input data through an applicable program or parameters (for respective channels).

Analog output / Digital input	1 ~ 5V	0 ~ 5V	0 ~ 10V	-10 ~ 10V
Unsigned value	0 ~ 16000			
Signed value	-8000 ~ 8000			
Precise value	1000 ~ 5000	0 ~ 5000	0 ~ 10000	-10000 ~ 10000
Percentile value	0 ~ 10000			

Analog output / Digital input	4 ~ 20mA	0 ~ 20mA
Unsigned value	0 ~ 16000	

## 2. Specifications

### 2.1. Performance specifications

Item	Specification			
	<i>2MLF-DV4S (Isolated Voltage Output Type)</i>		<i>2MLF-DC4S (Isolated Current Output Type)</i>	
	Signed value	-8000 ~ 8000		
	Precise value	4000 ~ 20000	0 ~ 20000	
	Percentile value	0 ~ 10000		
		1/16000 (for respective output range)		
Maximum resolution	1~5V	0.250mV	4~20mA	1.0μA
	0~5V	0.3125mV		
	0~10V	0.625mV	0~20mA	1.25μA
	±10V	1.250mV		
Accuracy	Standard accuracy: ±0.1% or less (when ambient temperature is 25°)			
	Temperature coefficient: ±80ppm/°C (0.008 %/°C)			
Maximum conversion speed	10ms/4 channels			
Absolute maximum output	±15V		±30mA	
Number of output channels	4 channels/1 module			
Isolation method	Photo-coupler isolation between input terminal and PLC power (Isolation between channels)			
Terminal connected	18-point terminal			
I/O points occupied	<b>Changeable type:</b> 16 points			
	<b>Fixed type:</b> 64 points			
Current	Internal	DC5V : 200mA	Internal	DC5V : 200mA



## 2. Specifications

### 2.1. Performance specifications

---

Item	Specification			
	<i>2MLF-DV4S (Isolated Voltage Output Type)</i>		<i>2MLF-DC4S (Isolated Current Output Type)</i>	
consumption	External	DC24V: 150mA	External	DC24V : 220mA
Weight (g)	150g			

## 2. Specifications

### 2.2. Respective designations and functions

---

## 2.2 Respective designations and functions

The following figure illustrates the respective designation of the parts.

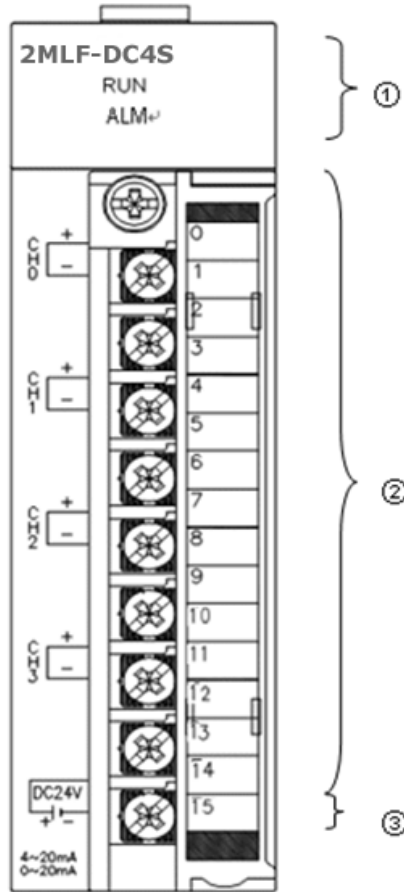

The following table provides description of the parts.

<b>Legend</b>	<b>Description</b>
<b>1</b>	<b>RUN LED</b> Displays the operation status of the isolated D/A conversion module. <ul style="list-style-type: none"><li>• <b>ON:</b> Operation normal</li><li>• <b>Flickering:</b> Error occurs (For more information, refer to Section 7.1)</li><li>• <b>OFF:</b> DC 5V disconnected, D/A conversion module error</li></ul>
<b>2</b>	<b>ALM LED</b> Displays the warning status of isolated D/A conversion module. <ul style="list-style-type: none"><li>• <b>Flickering:</b> Error occurs (control of change rate, limitation of output setting)</li><li>• <b>Off:</b> Operation normal</li></ul>
<b>3</b>	<b>Analog Terminal</b> The respective channels of the analog terminal can be connected to external devices.
<b>4</b>	<b>Power Terminal</b> Supply terminal of external power DC24V (No.17~18).

---

**2. Specifications**

2.3. Characteristics of I/O conversion

**2.3 Characteristics of I/O conversion**

**I/O conversion characteristics**

The characteristics of I/O conversion are displayed as a straight line with the inclination as shown in the following figure when converting digital signal to an analog signal (voltage or current) in the PLC.

Input formats of digital data are classified as unsigned value, signed value, precise value, and percentile value.

**Characteristic of voltage output**

You can select the voltage output range through a user program or special module parameters setting for respective channels.

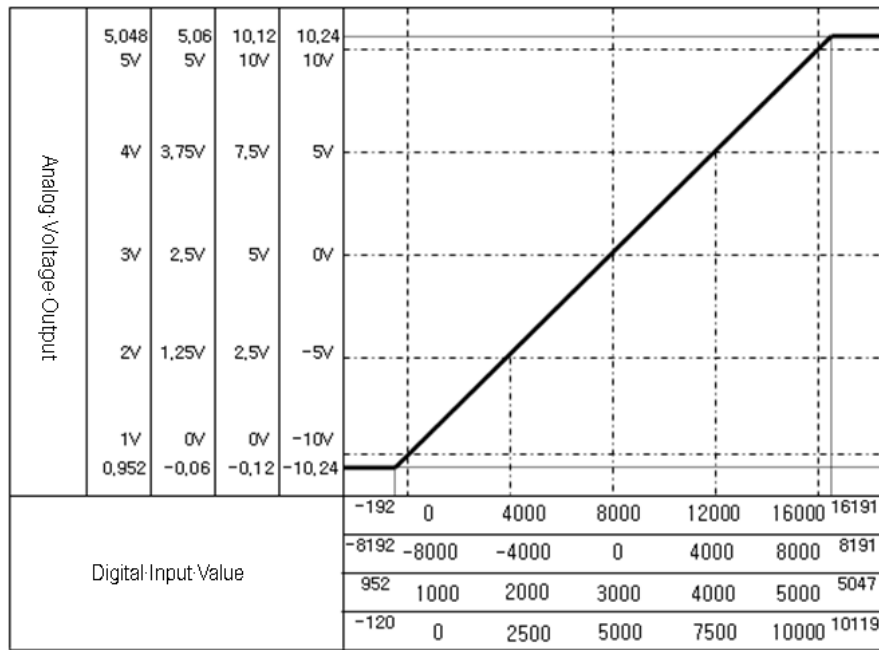

**2. Specifications**  
2.3. Characteristics of I/O conversion

1. If the range is 1~5V

Digital Input	Analog Voltage Output							Maximum Resolution
	0.952	1.0	2.0	3.0	4.0	5.0	5.048	
Unsigned value	-192	0	4000	8000	12000	16000	16191	0.25mV
Signed value	-8192	-8000	-4000	0	4000	8000	8191	
Precise value	952	1000	2000	3000	4000	5000	5047	1mV
Percentile value	-120	0	2500	5000	7500	10000	10119	0.40mV

In the case of 1~5V voltage output, analog voltage output for digital value of “1” is equivalent to 0.25mV, 1mV, 0.4mV.

2. If the range is 0~5V

Digital Input	Analog Voltage Output							Maximum Resolution
	-0.06	0.0	1.25	2.5	3.75	5.0	5.06	
Unsigned value	-192	0	4000	8000	12000	16000	16191	0.3125mV
Signed value	-8192	-8000	-4000	0	4000	8000	8191	
Precise value	-60	0	1250	2500	3750	5000	5059	1mV
Percentile value	-120	0	2500	5000	7500	10000	10119	0.50mV

In the case of 0~5V voltage output, analog voltage output for digital value of “1” is equivalent to 0.3125mV, 1mV, 0.5mV.

## 2. Specifications

### 2.3. Characteristics of I/O conversion

---

3. If the range is 0~10V

Digital Input	Analog Voltage Output							Maximum Resolution
	-0.12	0.0	2.5	5.0	7.5	10.0	10.12	
Unsigned value	-192	0	4000	8000	12000	16000	16191	0.625mV
Signed value	-8192	-8000	-4000	0	4000	8000	8191	
Precise value	-120	0	2500	5000	7500	10000	10119	1mV
Percentile value	-120	0	2500	5000	7500	10000	10119	

In the case of 0~10V voltage output, analog voltage output for digital value of “1” is equivalent to 0.625mV, 1mV.

4. If the range is -10~10V

Digital Input	Analog Voltage Output							Maximum Resolution
	-10.24	-10.0	-5.0	0.0	5.0	10.0	10.24	
Unsigned value	-192	0	4000	8000	12000	16000	16191	1.25mV
Signed value	-8192	-8000	-4000	0	4000	8000	8191	
Precise value	-10240	-10000	-5000	0	5000	10000	10238	1mV
Percentile value	-120	0	2500	5000	7500	10000	10119	2mV

In the case of -10~10V voltage output, analog voltage output for digital value of “1” is equivalent to 1.25mV, 1mV, 2mV.

### Characteristics of current output

You can select the current output range through a user program or special module parameters setting for respective channels.

**2. Specifications**  
2.3. Characteristics of I/O conversion

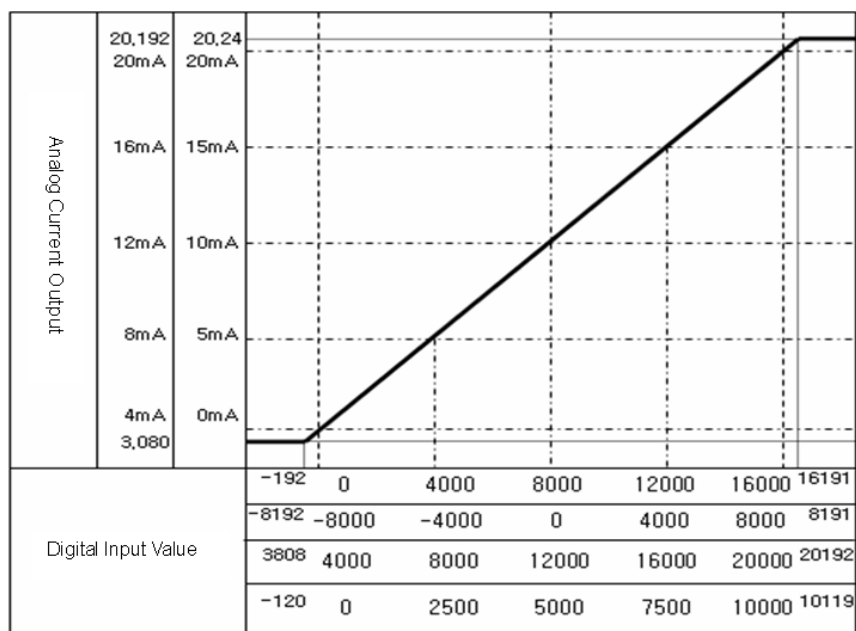

1. If the range is 4~20mA

Digital Input	Analog Current Output							Maximum Resolution
	3.808	4	8	12	16	20	20.192	
Unsigned value	-192	0	4000	8000	12000	16000	16191	1.0 $\mu$ A
Signed value	-8192	-8000	-4000	0	4000	8000	8191	
Precise value	3808	4000	8000	12000	16000	20000	20192	
Percentile value	-120	0	2500	5000	7500	10000	10119	1.6 $\mu$ A

In the case of 4~20mA current output, analog current output for digital value of “1” is equivalent to 1.0 $\mu$ A.

## 2. Specifications

### 2.3. Characteristics of I/O conversion

---

2. If the range is 0~20mA

Digital Input	Analog Current Output							Maximum Resolution
	-	0	5	10	15	20	20.24	
Unsigned value	0	0	4000	8000	12000	16000	16191	1.25 $\mu$ A
Signed value	0	-8000	-4000	0	4000	8000	8191	
Precise value	0	0	5000	10000	15000	20000	20192	1.0 $\mu$ A
Percentile value	0	0	2500	5000	7500	10000	10119	2.0 $\mu$ A

In the case of 0~20mA current output, analog current output for digital value of “1” is equivalent to 1.25 $\mu$ A.

#### Accuracy

Although the output range is changed, the accuracy of the analog output does not change.

The following figure shows the accuracy change range at the ambient temperature of 25  $\pm$  5°. The analog output range is set between 4 and 20mA and select an unsigned integer for the input type.

( $\pm$ 0.1% at 25  $\pm$  5°, 80ppm/° at 0 ~ 55°)



## 2. Specifications

### 2.3. Characteristics of I/O conversion

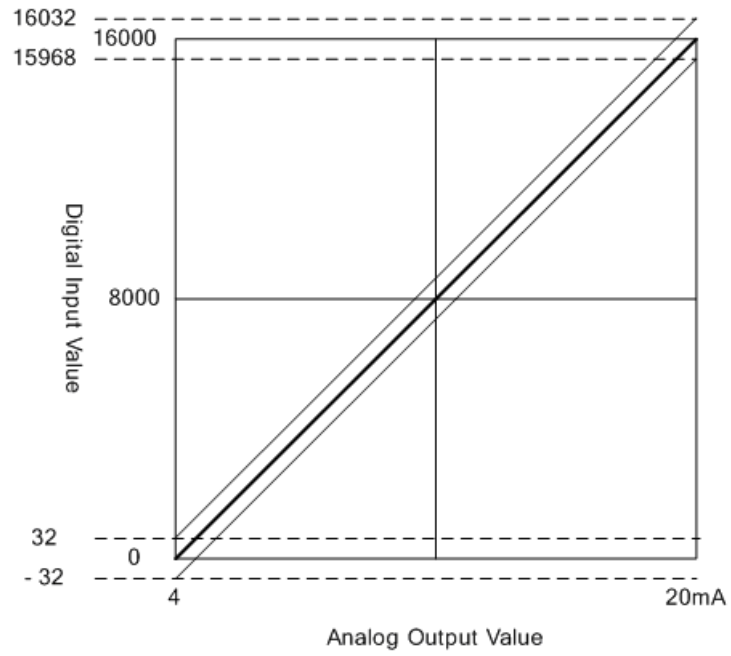

## 2.4 Main functions

### Output status setting

#### Normal mode

CPU Status	Output Status	Channel		Remarks
		Run	Stop	
RUN	Enabled	Digital value	0V or 0mA	0: previous value kept 1: minimum value output 2: middle value output 3: maximum value output
	Disabled	As specified setting output type	0V or 0mA	
STOP	Enabled	As specified setting output type	0V or 0mA	
	Disabled	As specified setting output type	0V or 0mA	

#### Test mode

CPU Status	Output Status	Channel		Remarks
		Run	Stop	
STOP	Enabled	Digital value	0V or 0mA	0: previous value kept 1: minimum output 2: middle output 3: maximum output
	Disabled	As specified setting output type	0V or 0mA	

Test mode is available only when CPU is in STOP status.

**If any isolated DA module error occurs**

CPU Status	Output Status	Channel		Remarks
		Run	Stop	
RUN	Enabled	ATTENTION	0V or 0mA	0: previous value kept 1: minimum output 2: middle output 3: maximum output
	Disabled	As specified setting output type	0V or 0mA	
STOP	Enabled	As specified setting output type	0V or 0mA	
	Disabled	As specified setting output type	0V or 0mA	
When Power is on /H/W error		0V or 0mA		



**ATTENTION**

- **Output value setting error:** upper limit or lower limit.
- **Parameter setting error:** as specified CH output type.

**If any CPU error occurs**

CPU Status	Output Status	Channel		Remarks
		Run	Stop	
ERROR	Enabled	0V or 0mA		
	Disabled			

**Display and diagnosis functions**

1. **Run LED:** Displays the operation status of isolated D/A conversion module.
  - **ON:** Operation normal
  - **Blinks:** Error occurs (Refer to error status below)
  - **Off:** DC 5V disconnected or module error

## 2. Specifications

### 2.4. Main functions

---

2. **Warning LED (ALM LED):** Displays the warning status of the isolated D/A conversion module.
  - **Flickering:** Warning occurs (when rate control, limitation of output is set)
  - **Off:** Operation normal
3. **Error status:** Classify and sort errors identified during the module operation.

Classification		Error Details	LED	Remarks
H/W	System error	Internal memory error	Blinks every 200ms	
		ASIC I/F error	Blinks every 200ms	
S/W	Parameters setting	Output status setting error	Blinks every 1s	
	Offset/Gain adjustment	Offset/Gain setting error	Blinks every 1s	



#### ATTENTION

When isolated D/A conversion module is released from the factory, Offset/Gain value is adjusted for respective analog output range, which the user cannot change.

---

## 2.5 Additional functions

### Output limit setting

This function enables the user to set the high/low output limit for digital inputs.

When the output limit function is set, if the set value of high limit value is more than the user defined digital value, the analog output value is the high limit value. And, if the user defined digital input is smaller than the low limit value, the analog output value is low limit value.

- **Output limit:** Disable/Enable
- **High limit value:** -192~16191 (Actual range is from low limit value to 16191.)
- **Low limit value:** -192~16191 (Actual range is from -192 to low limit value.)

Perform the following steps for I/O parameter setting.

Step	Action
1	On the <b>Project Window</b> of SoftMaster, click <b>I/O Parameters</b> . The <b>I/O Parameter Setting</b> window displays.
2	On the <b>I/O Parameters Setting</b> window, click the module area of the concerned slot to select the applicable module.  Click the arrow button on the Module cell, to display the modules. Select the applicable module.
3	Double-click the <b>2MLF-DC4S</b> module.  The module's <b>I/O Parameter Settings</b> window displays.

---

**2. Specifications**  
2.5. Additional functions

---

**Step** **Action**

---

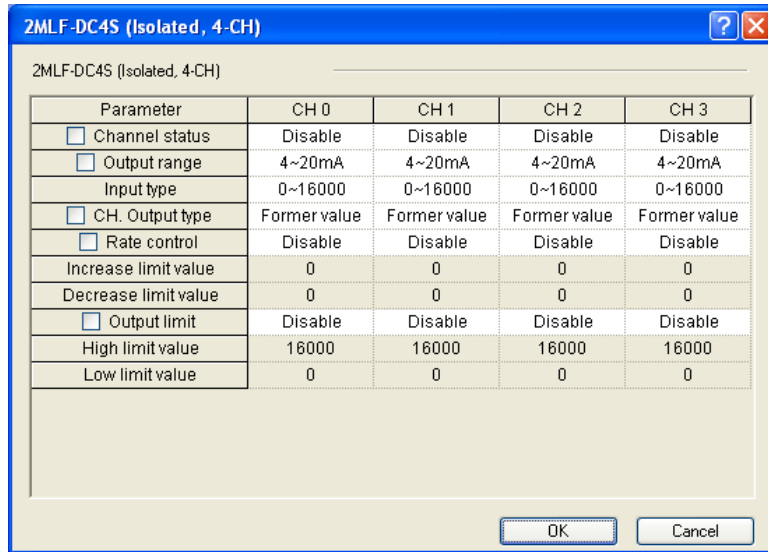

- 4 Set the output limit to **Enable**.
- Set the high limit value.
  - Set the low limit value.
-

Step

Action

Parameter	CH 0	CH 1	CH 2	CH 3
<input type="checkbox"/> Channel status	Disable	Disable	Disable	Disable
<input type="checkbox"/> Output range	4~20mA	4~20mA	4~20mA	4~20mA
Input type	0~16000	0~16000	0~16000	0~16000
<input type="checkbox"/> CH. Output type	Former value	Former value	Former value	Former value
<input type="checkbox"/> Rate control	Disable	Disable	Disable	Disable
Increase limit value	0	0	0	0
Decrease limit value	0	0	0	0
<input type="checkbox"/> Output limit	Enable	Disable	Disable	Disable
High limit value	14000	16000	16000	16000
Low limit value	200	0	0	0

-192~16000

OK Cancel

- 5 When the output limit is set, the analog output value is as shown in the following figure.

## 2. Specifications

### 2.5. Additional functions

---

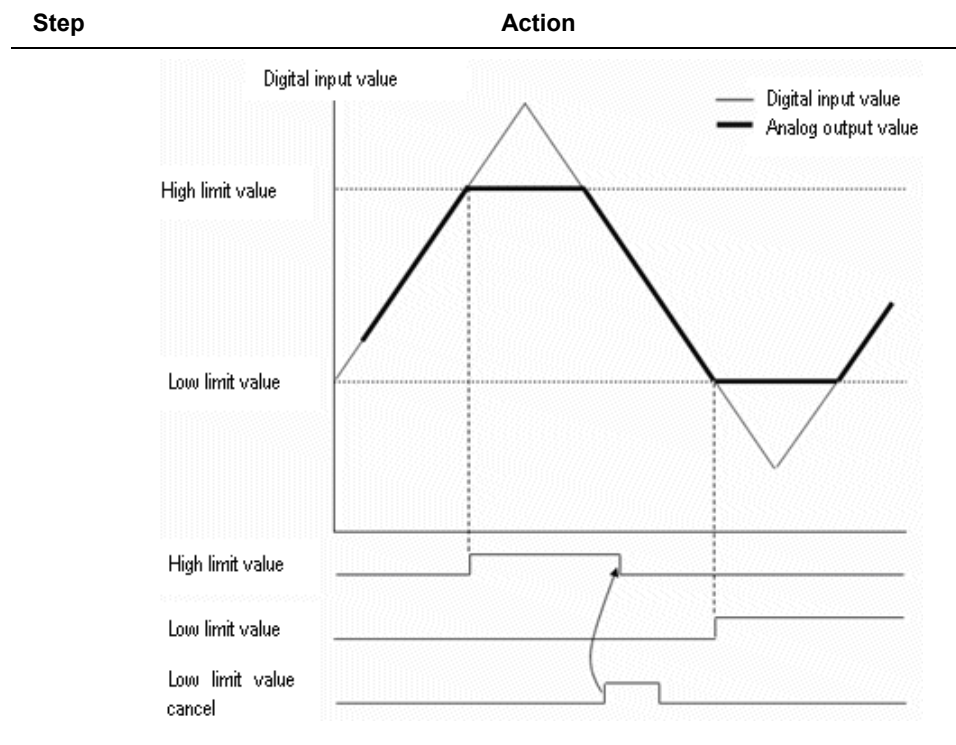

### Rate control setting

Rate control specifies the increase/decrease rate of analog output value for digital value, which is defined by user.

- **Rate control:** Disable/Enable
- **Increase limit value:** 0~16000
- **Decrease limit value:** 0~16000



Perform the following steps to configure I/O parameters.

- | Step | Action  |
|------|---|
| 1    | On the <b>Project Window</b> of SoftMaster, click <b>I/O Parameters</b> .<br><br>The <b>I/O Parameter Setting</b> window is displayed.  |
| 2    | On the <b>I/O Parameters Setting</b> window, click the module area of the concerned slot to select the applicable module.<br><br>Click the arrow button on the Module cell, to display the modules. Select the applicable module. |
| 3    | Double-click the <b>2MLF-DC4S</b> module.<br><br>The module's <b>I/O Parameter Settings</b> window is displayed.  |
| 4    | Set the <b>Rate control</b> setting to <b>Enable</b> .  |

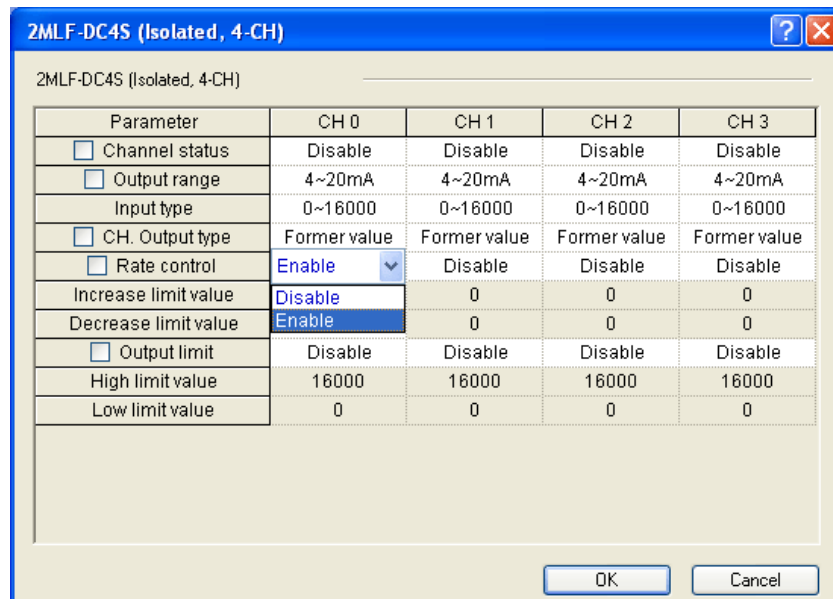

- Set the **Increase limit value** and the **Decrease limit value**.
- When the rate control is set, the analog output value is as shown in the following figure.

## 2. Specifications

### 2.5. Additional functions

---

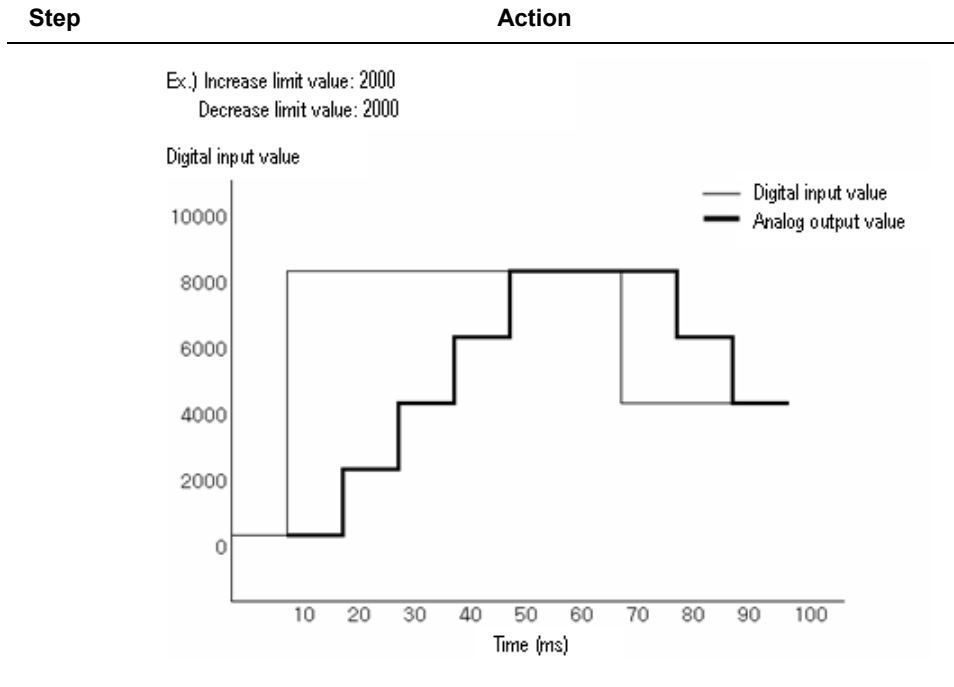

## 3. Installation and wiring

### 3.1 Before you begin

#### Safety instructions

For your safety and effective operation, read the safety instructions thoroughly before using the product.

- Safety instructions should always be observed in order to prevent accident or risk with the safe and proper use of the product.
- Instructions are separated into Warning and Caution.

#### Safety instructions when designing



#### WARNING

- Install protection circuit on the exterior of the PLC to protect the whole control system from any error in external power or PLC module. Any abnormal output or operation may be a safety threat to the whole system.
    - Install applicable protection unit on the exterior of PLC to protect the system from physical damage such as emergent stop switch, protection circuit, the upper/lower limit switch, forward/reverse operation interlock circuit, and so on.
    - If any system error (watch-dog timer error, module installation error, and, so on.) is detected during CPU operation in PLC, the whole output is designed to be turned off and stopped for system safety. However, in case CPU error is caused on output device itself such as relay or TR cannot be detected, the output may be kept on, which may cause serious problems. Thus, you are recommended to install an additional circuit to monitor the output status.
  - Never connect the overload than rated to the output module nor allow the output circuit to have a short circuit, which may cause a fire.
  - Never let the external power of the output circuit be designed to be on earlier than PLC power, which may cause abnormal output or operation.
  - In case of data exchange between computer or other external equipment and PLC through communication or any operation of PLC (For example, operation mode change), install interlock in the sequence program to protect the system from any error. If not, it may cause abnormal output or operation.
-

### 3. Installation and wiring

#### 3.1. Before you begin

---

- CAUTION**
- I/O signal or communication line will be wired at least 100mm away from a high-voltage cable or power line. If not, it may cause abnormal output or operation.
- 



**CAUTION**

- Use PLC only in the environment specified in PLC manual or general standard of data sheet. If not, it may cause an electric shock, fire, abnormal operation of the product or flames.
  - Before installing the module, be sure PLC power is off. If not, it may cause an electric shock or damage on the product.
  - Be sure that each module of PLC is correctly secured. If the product is installed loosely or incorrectly, it may cause an abnormal operation, error or dropping.
  - Be sure that I/O or extension connector is correctly secured. If not, it may cause an electric shock, fire or abnormal operation.
  - If a lot of vibration is expected in the installation environment, do not let PLC to directly vibrate. It may cause an electric shock, fire or abnormal operation.
  - Do not let any metallic foreign materials inside the product. It may cause an electric shock, fire or abnormal operation.
- 

#### Safety instructions when wiring

---



**WARNING**

- Prior to wiring, be sure that power of PLC and external power is turned off. If not, it may cause an electric shock or damage on the product.
  - Before PLC system is powered on, be sure that all the covers of the terminal are securely closed. If not, it may cause an electric shock.
-

### 3. Installation and wiring

#### 3.1. Before you begin

---



#### SHOCK HAZARD

- Let the wiring be installed correctly after checking the voltage rated of each product and the arrangement of terminals. If not, it may cause a fire, electric shock or abnormal operation.
  - Secure the screws of terminals tightly with specified torque when wiring. If the screws of terminals get loose, it may cause a short circuit, fire or abnormal operation
  - Use the ground wire of Class 3 for FG terminals, which is exclusively used for PLC. If the terminals are not grounded correctly, it may cause abnormal operation.
  - Do not let any foreign materials such as wiring waste inside the module while wiring. It may cause a fire, damage on the product or abnormal operation .
- 

#### Safety instructions for test-operation or repair

---



#### WARNING

- Do not touch the terminal when powered. It may cause an electric shock or abnormal operation.
  - Prior to cleaning or tightening the terminal screws, let all the external power off including PLC power. If not, it may cause an electric shock or abnormal operation.
  - Do not let the battery recharge, disassemble, heat, short or solder. It may cause injuries or fire, due to heat, explosion or ignition.
- 

#### CAUTION

- Do not remove PCB from the module case or remodel the module. It may cause fire, electric shock or abnormal operation.
  - Prior to installing or disassembling the module, let all the external power off including PLC power. If not, it may cause an electric shock or abnormal operation.
  - Keep all wireless installations or cell phone at least 30cm away from PLC. If not, it may cause an abnormal operation.
-

### 3. Installation and wiring

#### 3.2. Installation

---

#### Safety instructions for waste disposal

---

**CAUTION** Product or battery waste will be processed as industrial waste. The waste may discharge toxic materials or explode itself.

---

## 3.2 Installation

### Installation environment

The isolated D/A conversion module is designed to withstand extreme climatic conditions. However, care must be taken for the following items to ensure reliability and stability.

#### 1. Environmental conditions

- Install on a waterproof and dustproof control panel.
- Ensure that there is no continuous impact or vibration on the module.
- Avoid exposure to direct sunlight.
- Ensure that there is no dew formation caused by rapid change in temperature.
- Ensure an ambient temperature of 0-55°.

#### 2. Installation

- Ensure that wiring waste does not get inside PLC when wiring or drilling screw holes.
- Do not install on the same panel as a high-voltage device.
- Ensure a distance of at least 50mm from a duct or near-by module.
- Ensure that it is grounded in a place free from noise.

### **Precautions for handling**

Ensure the following precautions for handling the isolated D/A conversion module.

1. Ensure that the module is not dropped and subjected to shock.
2. Do not remove PCB from the case. It may cause abnormal operation.
3. Ensure that no foreign materials including wiring waste gets inside the module when wiring. Remove foreign materials if any inside.
4. Do not install or remove the module while power is On.

## **3.3 Wiring**

### **Wiring precautions**

1. Use a cable for external output sign of D/A conversion module separate from the alternating current to insulate it from surge or inductive noise produced from the alternating current side.
2. Select a cable taking into consideration the ambient temperature and allowable current, whose size is not less than the max. cable standard of AWG22 (0.3mm<sup>2</sup>).
3. Do not let the cable too close to hot device and material or in direct contact with oil for long, which will cause damage or abnormal operation due to short-circuit.
4. Check the polarity when wiring the terminal.
5. Wiring with high-voltage line or power line may produce inductive hindrance causing abnormal operation or defect.

### 3. Installation and wiring

#### 3.3. Wiring

---

#### Wiring examples

##### 1. 2MLF-DV4S

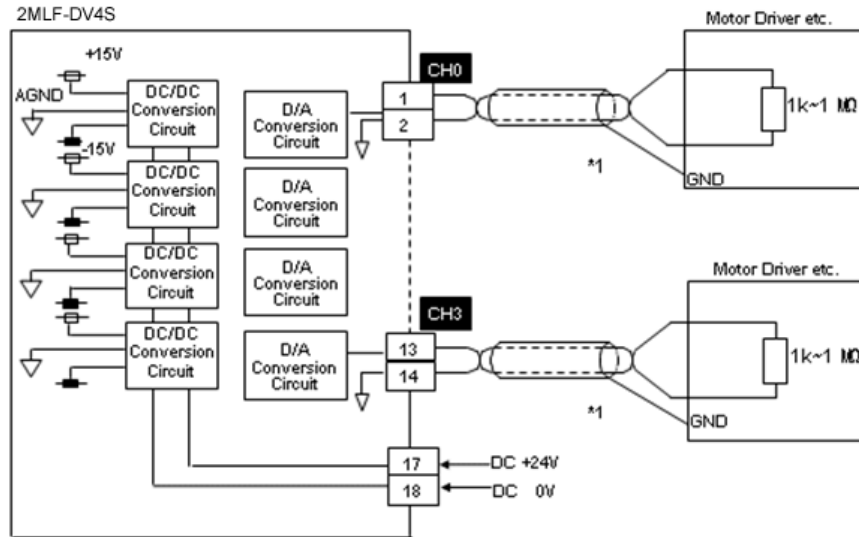



2. 2MLF-DC4S

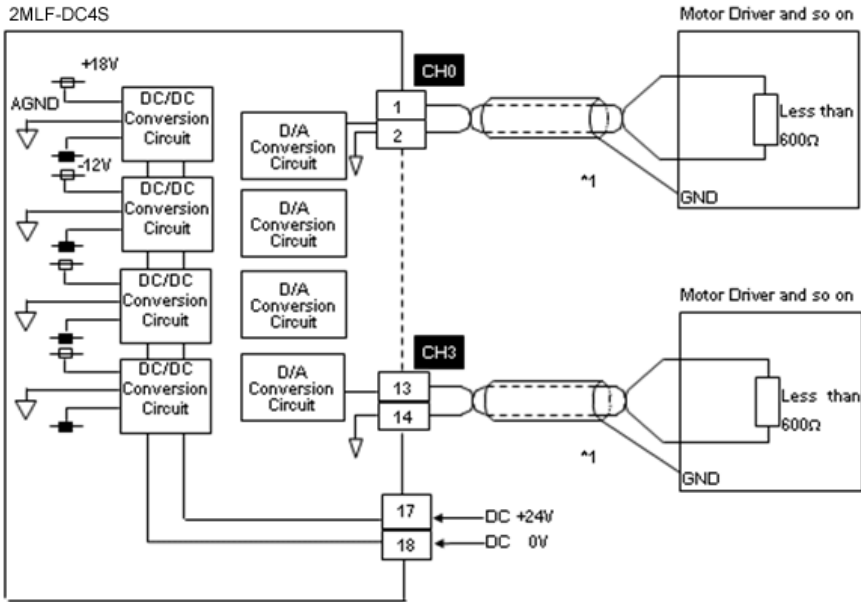

\*1: Use a 2-core twisted shielded wire.

**3. Installation and wiring**  
**3.4. Wiring of DC 24V**

---

**3.4 Wiring of DC 24V**

**Specification of power supply**

Described below is the DC24V specification of 2MLF-PA1A.

Rated Output Voltage	DC24V
Output Current	0.6A
Range of Output Voltage	21.6 ~ 26.4V
Fluctuation of Output Voltage	±10%

If 2MLP-ACF1 power module is used.

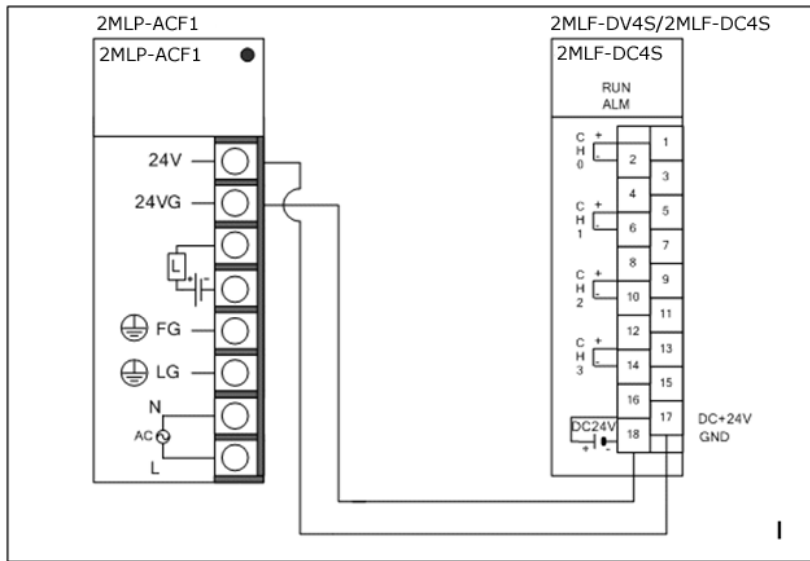

**ATTENTION**

If more than one isolated analog output module is used, see section [Performance specifications](#), to calculate DC24V consumed power for the application appropriate to power capacity.

**Using an external power module**

- If an external power supply is used, connect isolated D/A conversion module with DC+24V of the external power supply.
- If an external power supply is used, a noise filter is recommended for D/A conversion module side.
- See section [Specification of power supply](#), for details on power specification of DC+24V necessary for isolated D/A conversion module.

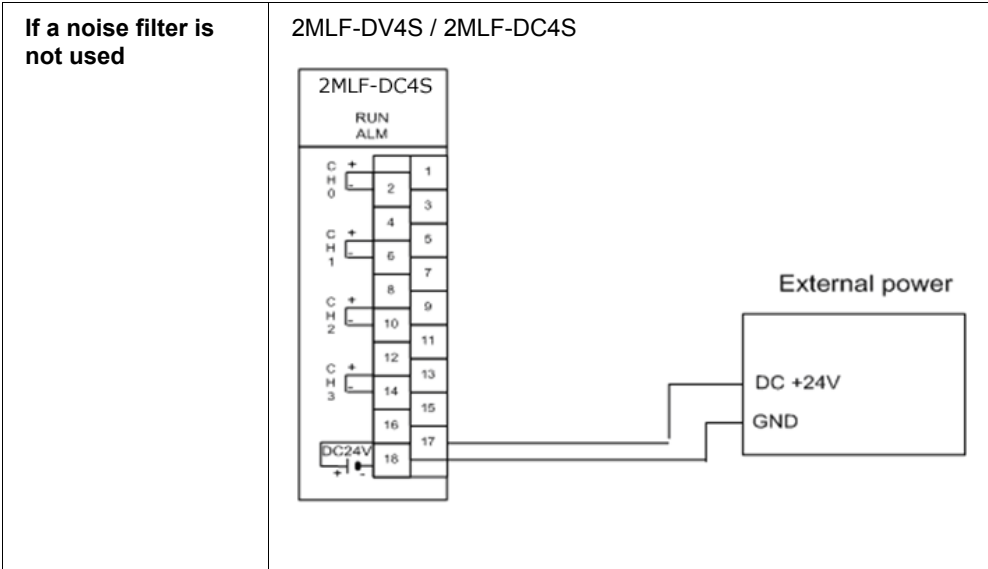

### 3. Installation and wiring

#### 3.4. Wiring of DC 24V

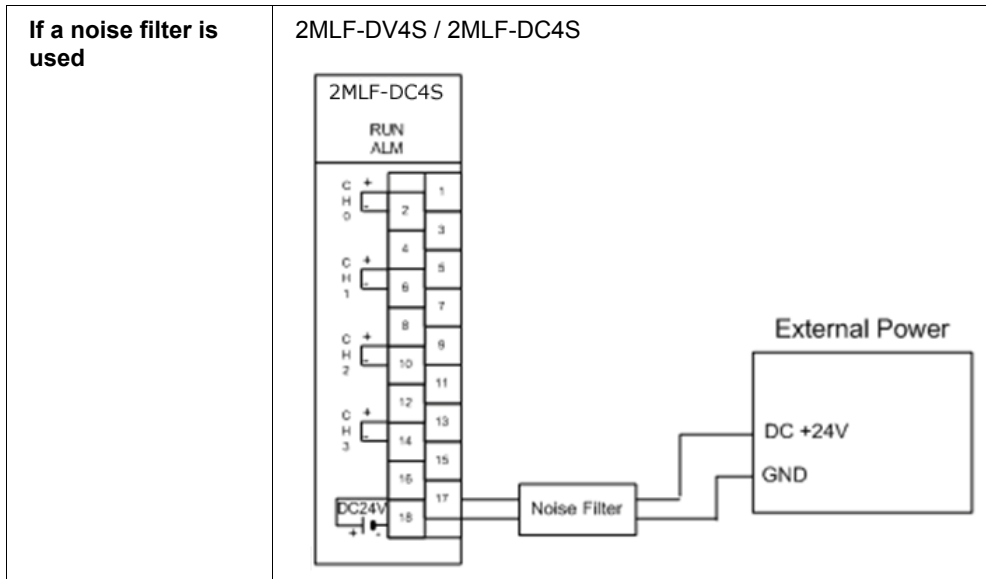

#### ATTENTION

1. Wiring between noise filter and isolated D/A conversion module must be separated from other cables.
2. Wiring between noise filter and isolated D/A conversion module must be as short as possible.

## 4. Operations and Monitoring

### 4.1 Operations

The following figure illustrates the process for operating the isolated analog output module.

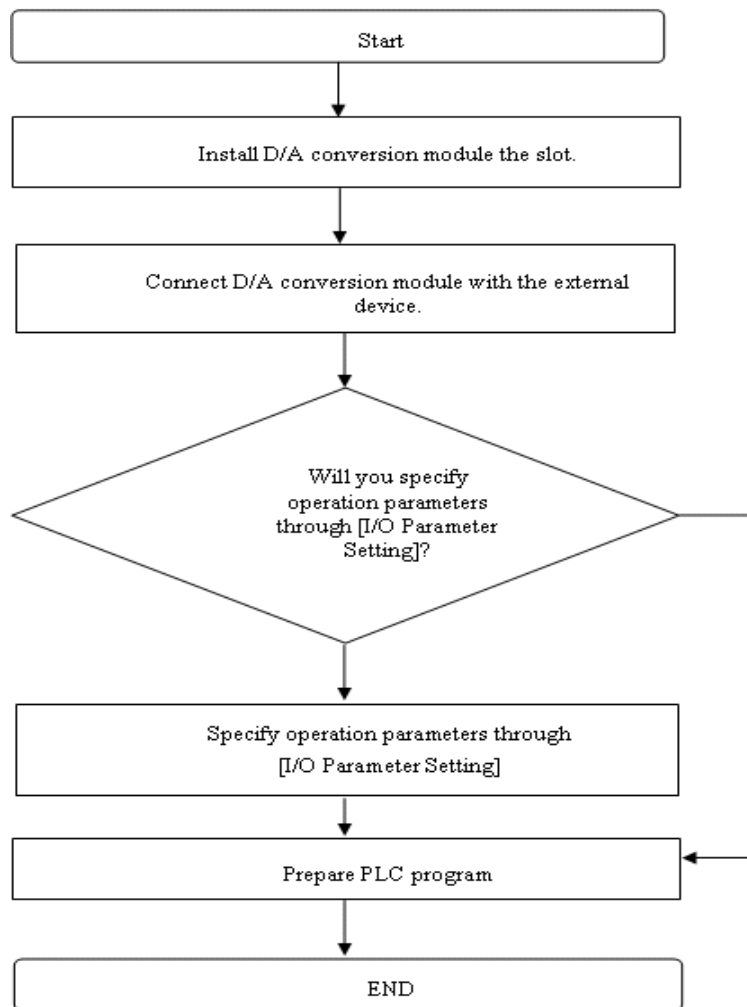

## 4. Operations and Monitoring

### 4.2. Configuring parameters

---

## 4.2 Configuring parameters

You can specify the isolated D/A conversion module's operating parameters through SoftMaster's **I/O Parameters** setting window.

### Setting items

Isolated D/A conversion module is used to set parameters and monitor/test the applicable module using the SoftMaster menu or tool bar, or read/write the data of internal memory by means of the scan program.

The **SoftMasters's I/O Parameter Setting** window interface (invoked from the project window) is used to configure the parameters of isolated D/A conversion module.

The following table lists the functions of the I/O parameters.

Item	Details
I/O parameters	<p>Specify the following setting items necessary for the module operation.</p> <ul style="list-style-type: none"><li>• Channel status</li><li>• Output range</li><li>• Input type</li><li>• Channel output type</li><li>• Rate control</li><li>• Increase/Decrease limit value</li><li>• Output limit</li><li>• High/Low limit value</li></ul> <p>The user specified data in SoftMaster is saved on the D/A conversion module when <b>Special Module Parameters</b> are downloaded. In other words, the point of time when [Special Module Parameters] are saved on D/A conversion module has nothing to do with PLC CPU's status Enable or Disable.</p>

### Using I/O parameters

Perform the following steps, to configure I/O parameters for 2MLF-DV4S/2MLF-DC4S.

Step	Action
1	Open <b>SoftMaster</b> and create a project. (For details on how to create the project, refer to the SoftMaster User's Guide)
2	On the <b>Project Window</b> , double-click <b>I/O Parameters</b> .

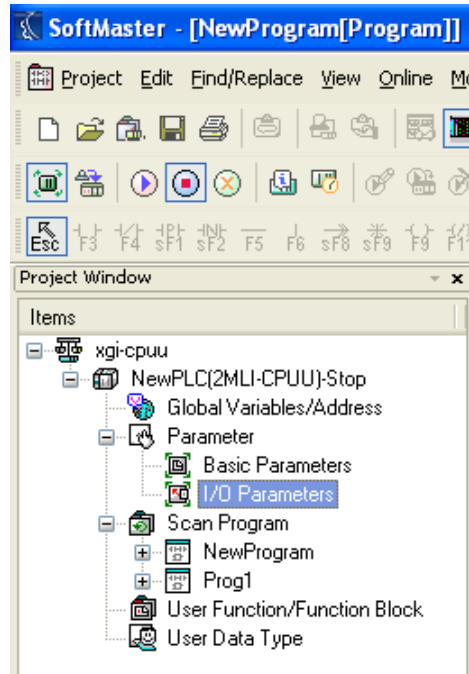

## 4.3 Parameter configuration

### Configuring parameters

Step	Action
1	Open SoftMaster and create a project. (For details on how to create the project, refer to the SoftMaster User's Guide)
2	On the <b>Project Window</b> of SoftMaster, double-click <b>I/O parameters</b> . The <b>I/O Parameters Setting</b> window is displayed.

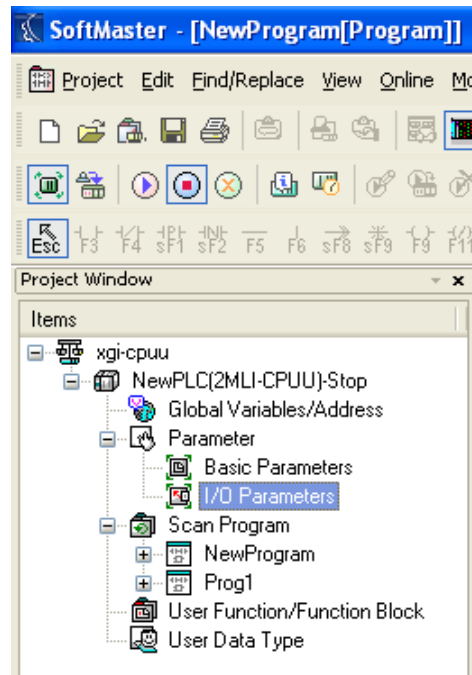

- 3 Click the **Module** area of the applicable slot to select the applicable module.
  - 4 On the **I/O Parameter Setting** window, select the slot of the base on which the D/A conversion module is installed.
  - 5 Click the arrow on the **Module** column to select an applicable module from the list.
-



4. Operations and Monitoring  
4.3. Parameter configuration

Step Action

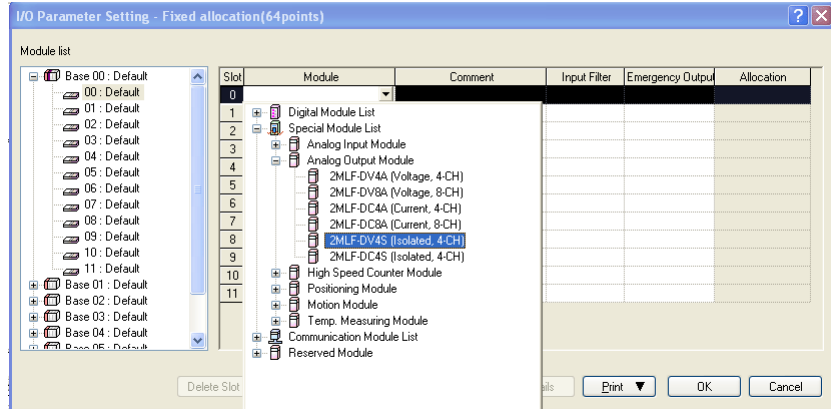

Double-click the applicable module or click **Details** to configure parameters.

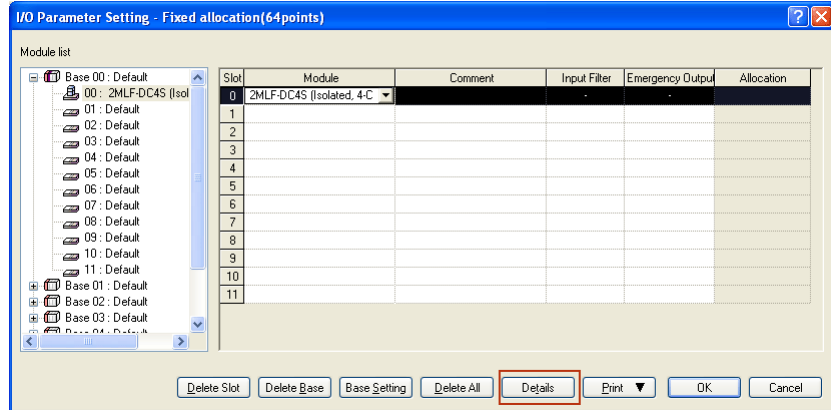

**4. Operations and Monitoring**  
**4.3. Parameter configuration**

---

**Step** **Action**

---

**Set Channel status:** Select **Disable** or **Enable**.

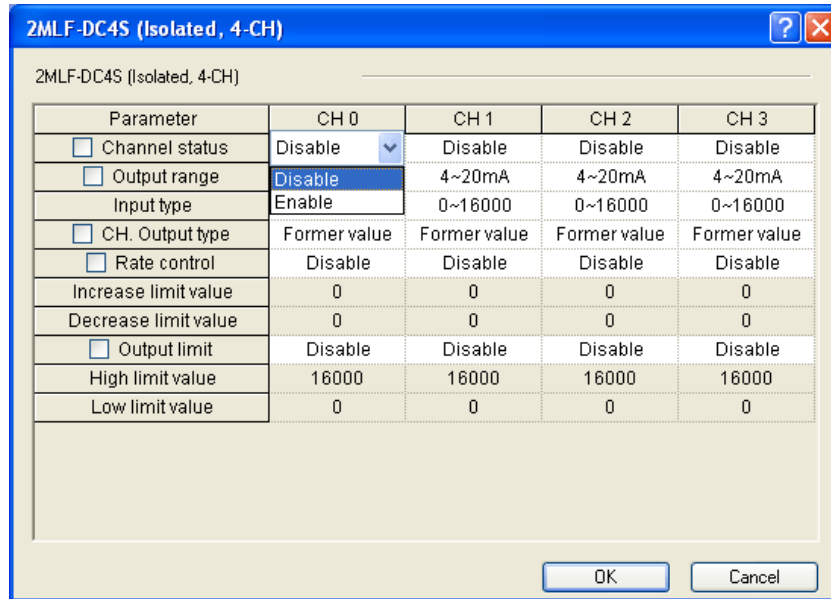

**Set Analog output range:** Select the range of analog output voltage as desired.

2MLF-DV4S provides four voltage output ranges, and 2MLF-DC4S provides two current output ranges.

---

Step

Action

Parameter	CH 0	CH 1	CH 2	CH 3
<input type="checkbox"/> Channel status	Disable	Disable	Disable	Disable
<input type="checkbox"/> Output range	4~20mA	4~20mA	4~20mA	4~20mA
Input type	4~20mA	0~16000	0~16000	0~16000
<input type="checkbox"/> CH. Output type	0~20mA	Former value	Former value	Former value
<input type="checkbox"/> Rate control	Disable	Disable	Disable	Disable
Increase limit value	0	0	0	0
Decrease limit value	0	0	0	0
<input type="checkbox"/> Output limit	Disable	Disable	Disable	Disable
High limit value	16000	16000	16000	16000
Low limit value	0	0	0	0

**Input data type:** Select the format of input data.

Four formats are available in total.

**4. Operations and Monitoring**  
**4.3. Parameter configuration**

---

**Step** **Action**

---

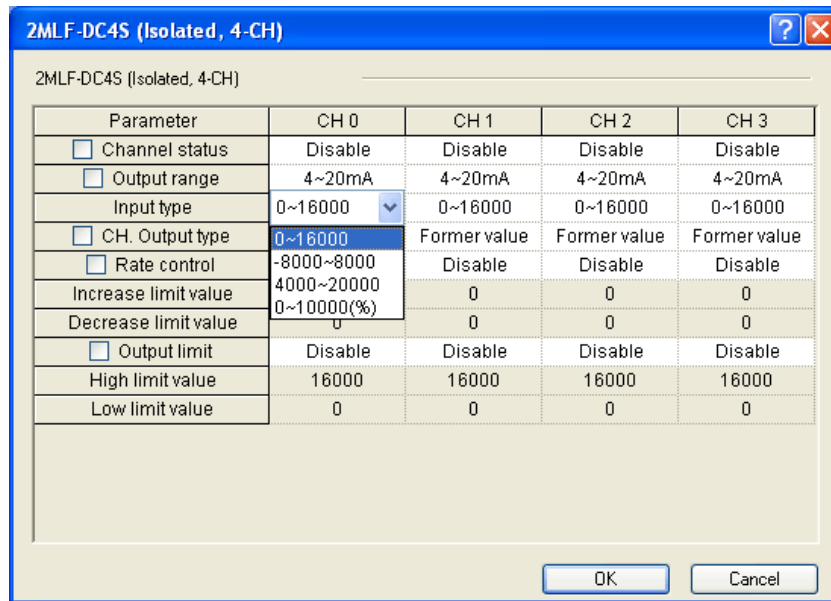

**Setting output type:** Select the type of output status.

Four ranges are available in total.

---

**4. Operations and Monitoring**  
**4.3. Parameter configuration**

**Step**

**Action**

Parameter	CH 0	CH 1	CH 2	CH 3
<input type="checkbox"/> Channel status	Disable	Disable	Disable	Disable
<input type="checkbox"/> Output range	4~20mA	4~20mA	4~20mA	4~20mA
Input type	0~16000	0~16000	0~16000	0~16000
<input type="checkbox"/> CH. Output type	Former value	Former value	Former value	Former value
<input type="checkbox"/> Rate control	Former value	Disable	Disable	Disable
Increase limit value	Min value	0	0	0
Decrease limit value	Mid value	0	0	0
<input type="checkbox"/> Output limit	Max value	Disable	Disable	Disable
High limit value	16000	16000	16000	16000
Low limit value	0	0	0	0

**Rate control:** Select **Disable** or **Enable**.

**4. Operations and Monitoring**  
**4.3. Parameter configuration**

---

**Step** **Action**

---

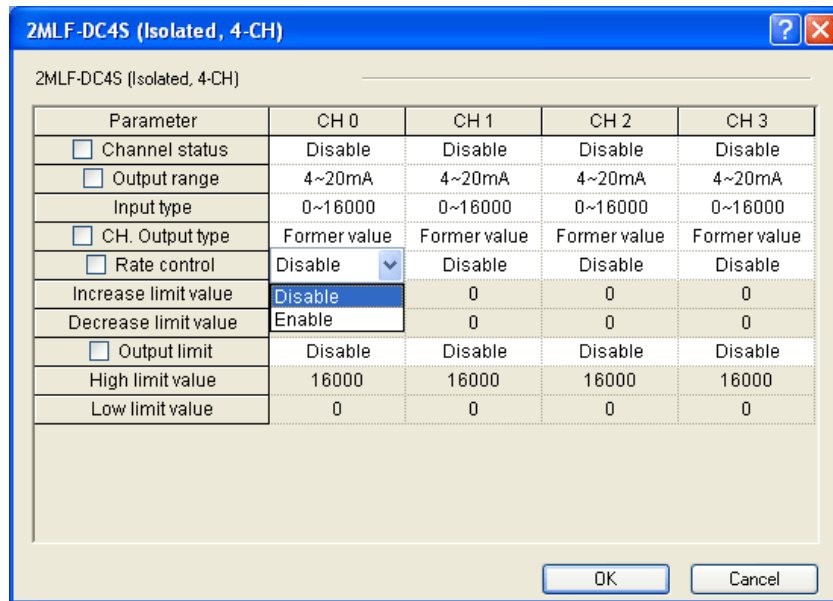

**Increase/Decrease limit value:** The setting range is from 0 to 16000.

---

Step

Action

2MLF-DC4S (Isolated, 4-CH)

2MLF-DC4S (Isolated, 4-CH)

Parameter	CH 0	CH 1	CH 2	CH 3
<input type="checkbox"/> Channel status	Disable	Disable	Disable	Disable
<input type="checkbox"/> Output range	4~20mA	4~20mA	4~20mA	4~20mA
Input type	0~16000	0~16000	0~16000	0~16000
<input type="checkbox"/> CH. Output type	Former value	Former value	Former value	Former value
<input type="checkbox"/> Rate control	Enable	Disable	Disable	Disable
Increase limit value	2000	0	0	0
Decrease limit value	0	0	0	0
<input type="checkbox"/> Output limit	Disable	Disable	Disable	Disable
High limit value	16000	16000	16000	16000
Low limit value	0	0	0	0

0~16000

OK Cancel

**Output limit setting:** Select **Disable** or **Enable**.

**4. Operations and Monitoring**  
**4.3. Parameter configuration**

---

**Step** **Action**

---

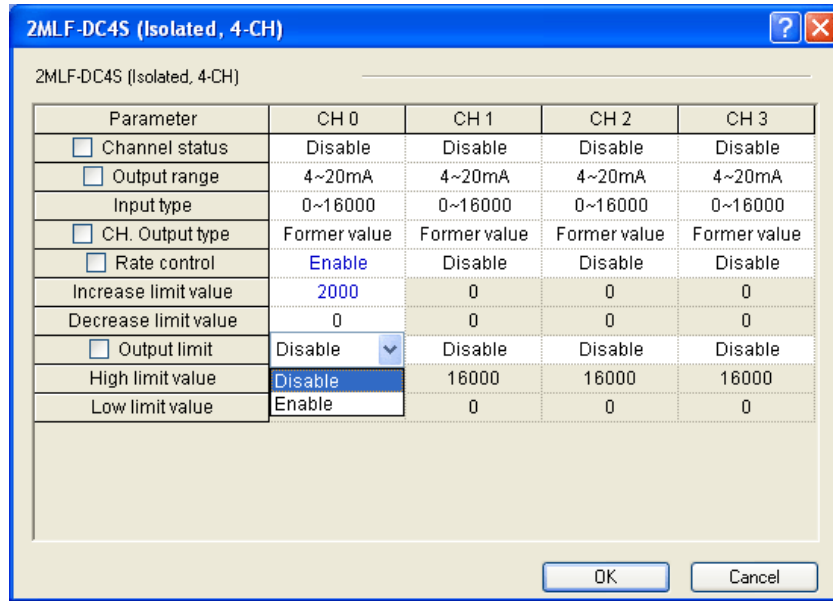

**High/Low limit value:** The setting range is from -192 to 16191.

---



Step

Action

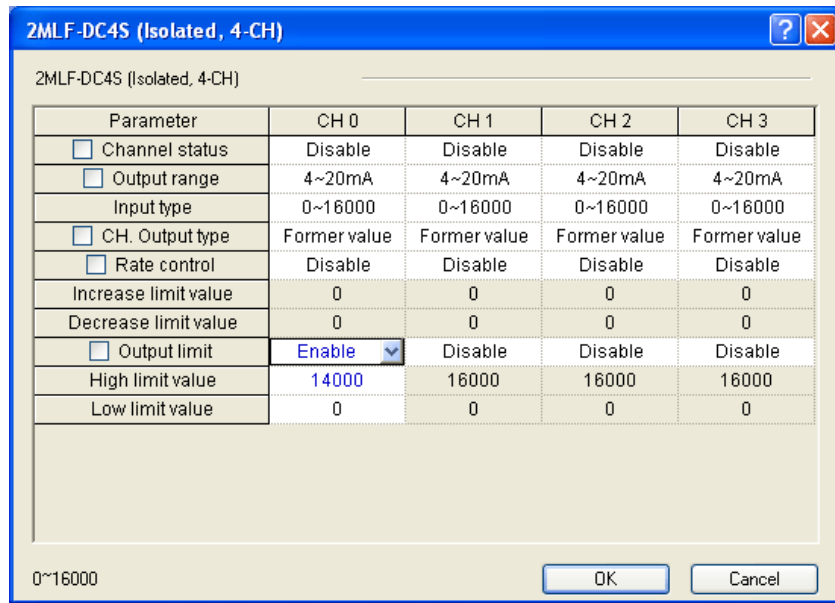

6 Specify all the parameters. Set all parameters and click **OK**.

7 The following table describes all default parameter settings.

Parameter	Setting Item	Default
Channel status	Enable/Disable	Disable
Output range	1~5V/0~5V/0~10V/-10~10V (voltage type) 4~20mA/0~20mA (current type)	1~5V 4~20mA
Input type	0~16000/-8000~8000/1000-5000/0~10000% (Changed based on the output range)	0~16000
Ch. Output type	Prev/Min/Mid/Max	Previous
Rate control	Disable/Enable	Disable
Increase limit value	0~16000	0
Decrease limit value	0~16000	0
Output limit	Disable/Enable	Disable
High limit value	-192~16191	16000
Low limit value	-192~16191	0

8 To set identical parameter for all the channels, select the **Channel Status**

**4. Operations and Monitoring**  
**4.3. Parameter configuration**

---

**Step**

**Action**

corresponding to all channels. Change the parameter as Enable/Disable for one channel; it will reflect for the rest of the channels.

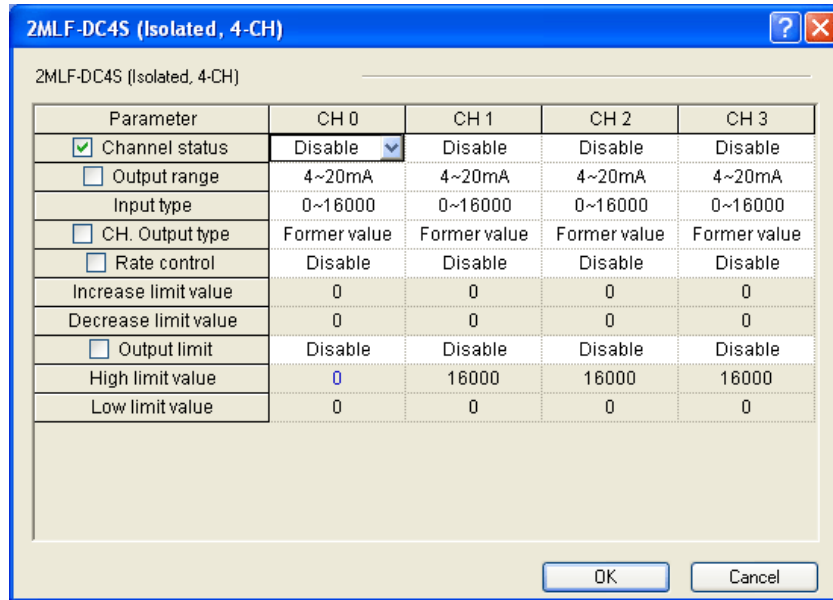

## 4.4 Monitoring or testing

### Monitoring or testing window

Perform the following steps to monitor the isolated D/A conversion module.

Step	Action
1	<p>In the SoftMaster, from the <b>Online</b> menu, select <b>Connect</b>.</p> <p>From the <b>Monitor</b> menu, select <b>Special Module Monitoring</b> to start monitoring.</p> <p>If the PLC CPU status is not <b>Online</b>, then the <b>Special Module Monitoring</b> option is disabled.</p>

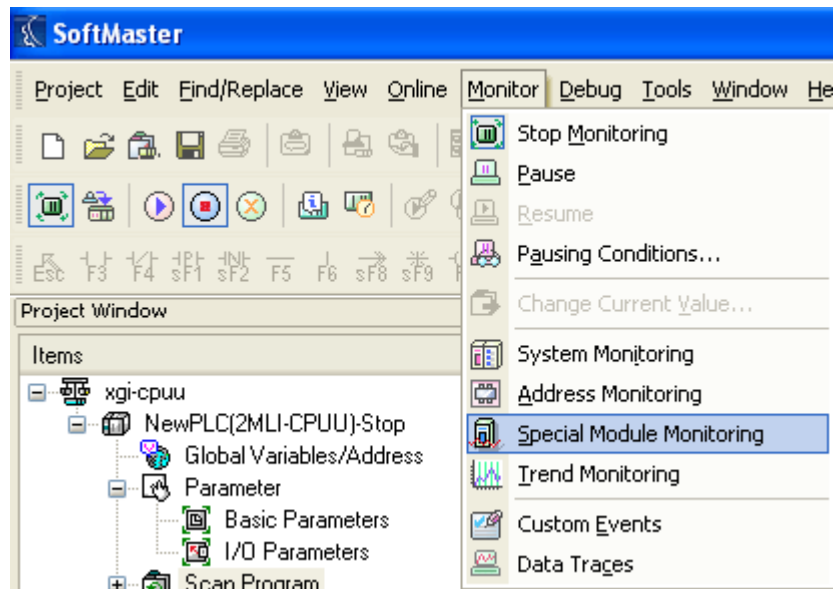

- 2 With SoftMaster connected to PLC CPU (Online status), from the **Monitor** menu, select **Special Module Monitoring** to display the Special Module List window, which displays base or slot information in addition to special module type. The list dialog box displays the module currently installed on the PLC system.

#### 4. Operations and Monitoring

##### 4.4. Monitoring or testing

---

Step

Action

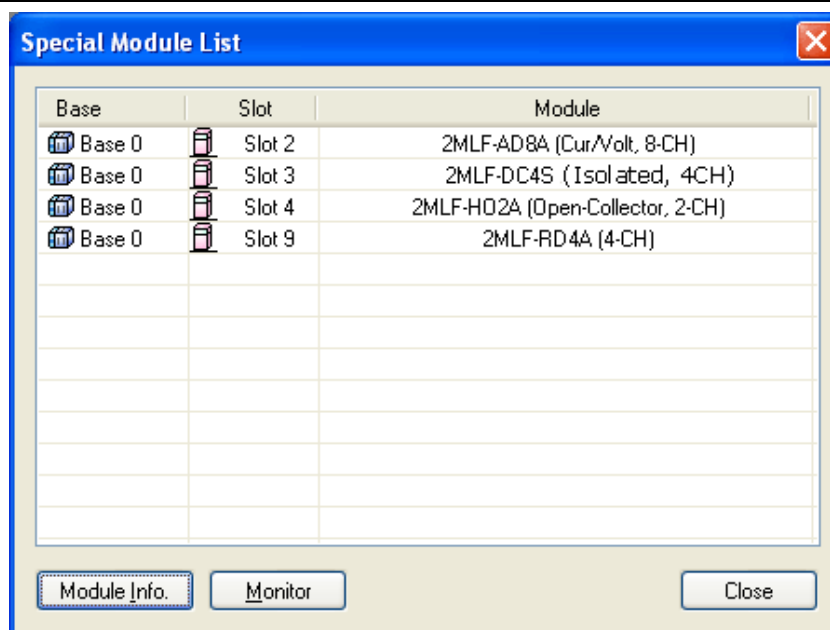

- | Step | Action  |
|------|---|
| 3    | Select <b>Special Module</b> and click <b>Module Info.</b> to display the special module information. The following figure displays special module information. |

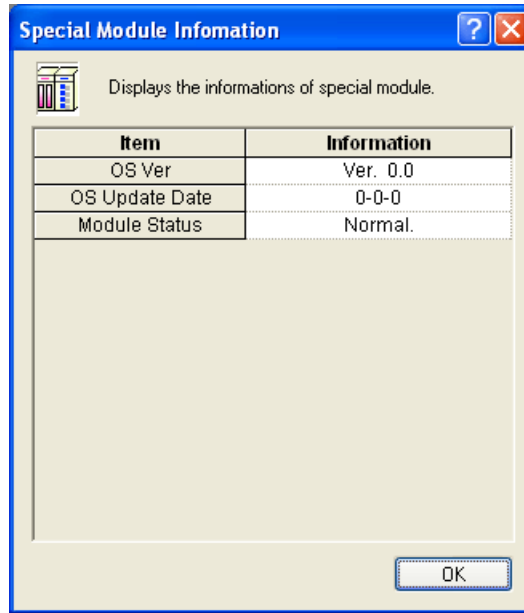

- |   |   |
|---|---|
| 4 | After the module is selected, click <b>Monitor</b> and the monitoring window displays The following figure displays special module monitor details. |
|---|---|
-

## 4. Operations and Monitoring

### 4.4. Monitoring or testing

---

#### Step

#### Action

---

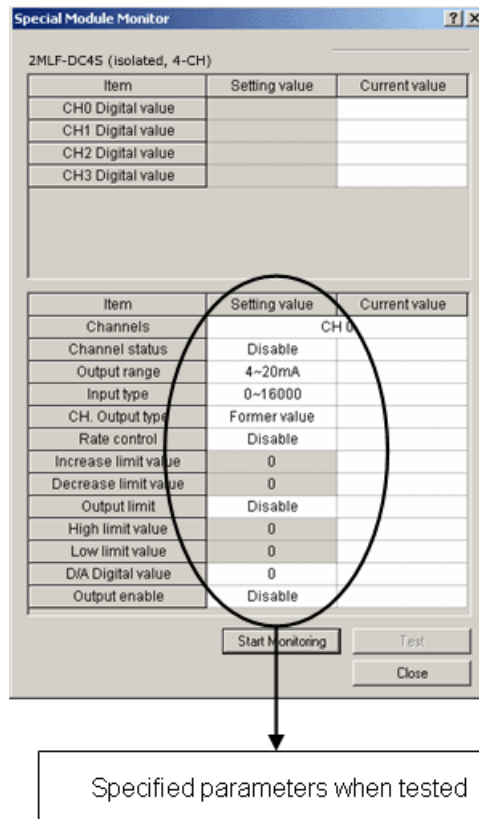

- 5 Start Monitoring:** Click **Start Monitoring** to display D/A output value of the presently operated channel.

The following figure is the monitoring window displayed when the whole channels of 2MLF-DV4S are in Run mode.

---

Step	Action

- 6 **Test:** It is used to change the currently specified parameters of D/A conversion module. Click Test, which is in lower half of the window to change the parameters.

**Test** can be set only when CPU operation status is in **Stop Monitoring**.

## 4. Operations and Monitoring

### 4.5. Register special module variables

Step

Action

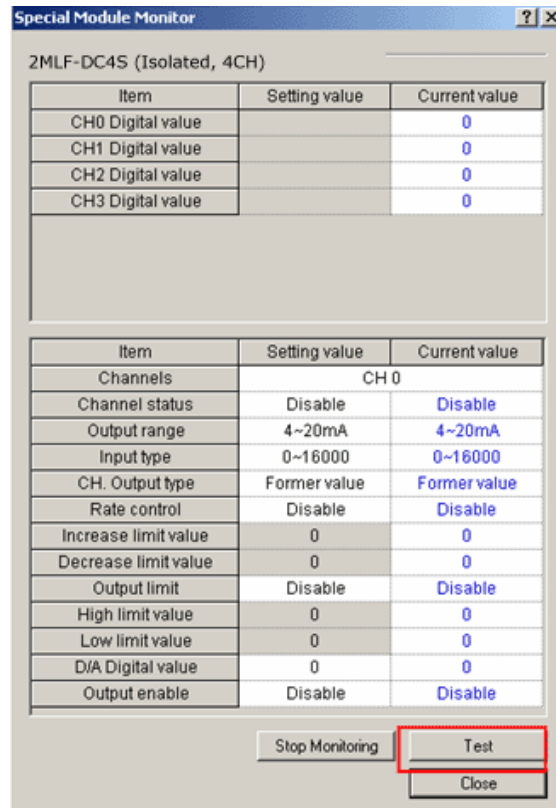

Select the **Setting value**, click **Test** and change **Current value**.

- 7 **Close:** It is used to close from the monitoring/test window.

### Programmatic operation of the module

D/A conversion module can be operated with Tx. (Write) instruction of PUT/PUTP and Rx. (Read) instruction of GET/GETP executed from PLC CPU by means of the scan program.



#### REFERENCE - INTERNAL

For more details, refer to section [Programming](#).



## 4.5 Register special module variables

This section describes the automatic registration function of special module variables in the SoftMaster.

### Registering special module variables

Register the variables for each module referring to the special module information that is set in the I/O parameter. You can modify the variables and comments.

The following procedure describes the automatic registration of the special module variables.

Step	Action
1	On the <b>I/O Parameter Setting</b> window, select the special module type.

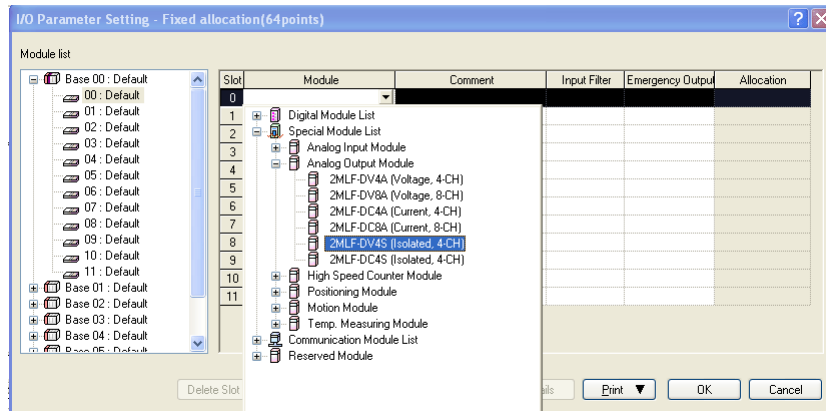

2	On the <b>Project Window</b> , double-click <b>Global Variable/Address</b> .
---	--

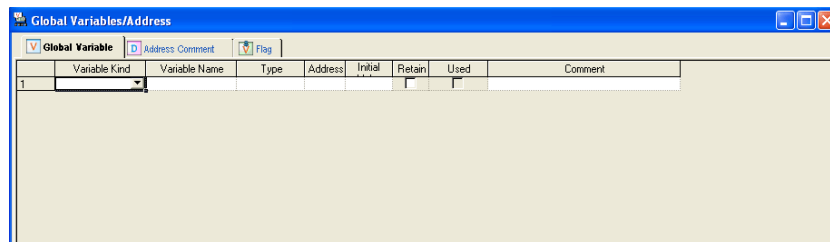

**4. Operations and Monitoring**  
**4.5. Register special module variables**

---

- | Step | Action   |
|------|--|
| 3    | From the <b>Edit</b> menu, select <b>Register Special Module Variables</b> . |

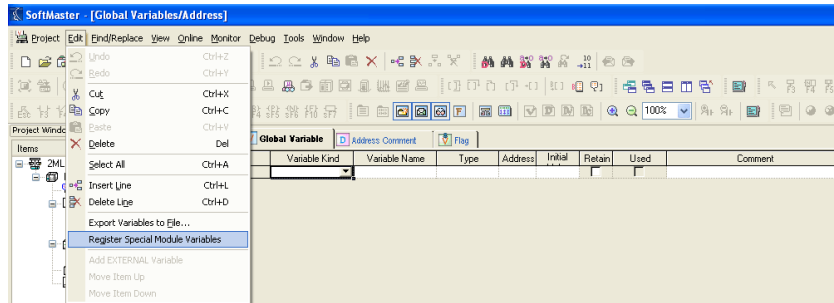

- 4 Click **Yes** on the confirmation message dialog box to register the special module variables.

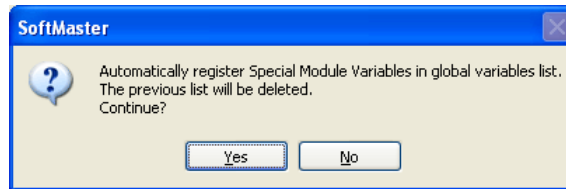

- 5 The variables are registered and the following figure displays all registered variables.

The screenshot shows the 'Global Variables/Address' window with a table of registered variables. The table has columns for Variable Kind, Variable Name, Type, Address, Initial, Retain, and Use.

Variable Kind	Variable Name	Type	Address	Initial	Retain	Use
VAR_GLOBAL_CO	F09_CH3_AVG_S	UINT		13	<input type="checkbox"/>	<input type="checkbox"/>
VAR_GLOBAL_CO	F09_CH3_AVG_V	UINT		17	<input type="checkbox"/>	<input type="checkbox"/>
VAR_GLOBAL_CO	F09_CH3_BOUT	UINT		71	<input type="checkbox"/>	<input type="checkbox"/>
VAR_GLOBAL_CO	F09_CH3_ERR_C	UINT		63	<input type="checkbox"/>	<input type="checkbox"/>
VAR_GLOBAL_CO	F09_CH3_FILT_C	UINT		09	<input type="checkbox"/>	<input type="checkbox"/>
VAR_GLOBAL_CO	F09_CH3_PAHH	UINT		39	<input type="checkbox"/>	<input type="checkbox"/>
VAR_GLOBAL_CO	F09_CH3_PAH_V	UINT		40	<input type="checkbox"/>	<input type="checkbox"/>
VAR_GLOBAL_CO	F09_CH3_PALL_V	UINT		42	<input type="checkbox"/>	<input type="checkbox"/>
VAR_GLOBAL_CO	F09_CH3_PAL_VA	UINT		41	<input type="checkbox"/>	<input type="checkbox"/>
VAR_GLOBAL_CO	F09_CH3_PA_HY	UINT		46	<input type="checkbox"/>	<input type="checkbox"/>
VAR_GLOBAL_CO	F09_CH3_PAH_V	UINT		54	<input type="checkbox"/>	<input type="checkbox"/>

**Saving variables**

Variable information can be saved as a text file. Perform the following steps, to save variables as a text file.

Step	Action
1	From the <b>View</b> menu, select <b>Variables</b> .
2	From the <b>Project</b> menu, select <b>Export to file</b> .
3	The variable information is saved as a text file.

**View variables**

Step	Action
1	The following figure displays an example program of SoftMaster.

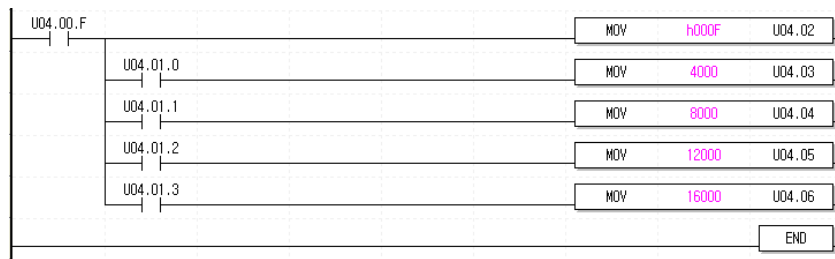

- 2 From the **View** menu, select **Variables**.  
The addresses are changed into variables.

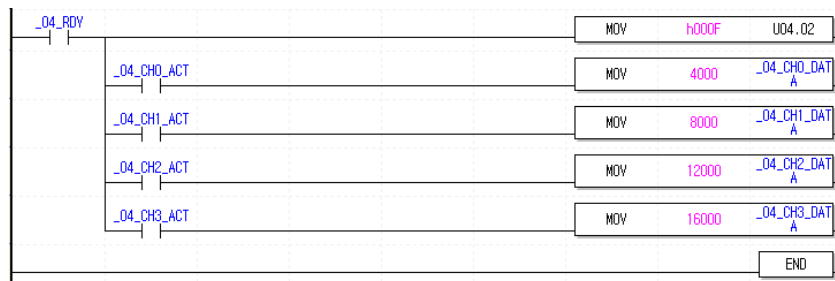

## 4. Operations and Monitoring

### 4.5. Register special module variables

---

Step	Action
------	--------

---

**3** From the **View** menu, select **Address/Variables**.

Displays both addresses and variables.

U04.00.F		MOV	h000F	U04.02
U04.01.0		MOV	4000	U04.03
U04.01.1		MOV	8000	U04.04
U04.01.2		MOV	12000	U04.05
U04.01.3		MOV	16000	U04.06
				END

**4** From the **View** menu, select **Address/Comments**.

Displays both addresses and comments.

---

**4. Operations and Monitoring**  
**4.5. Register special module variables**

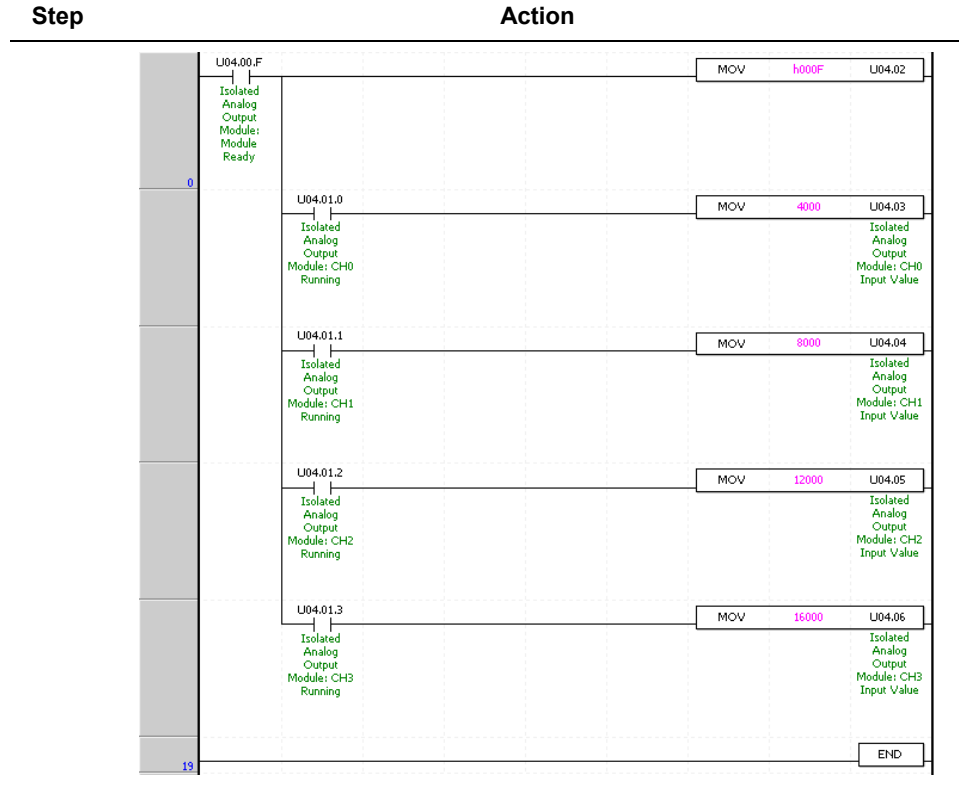

**ATTENTION**

**Register Special/Communication Module Variables** function deletes the previous Special Module Variables information and Variable/Comment is added to Variable/Comment list referring to the current I/O parameter.

## **4. Operations and Monitoring**

### **4.5. Register special module variables**

---

## 5. Internal Memory Configuration

### 5.1 Configuring internal memory

#### I/O area of D/A converted data

The following table displays I/O area of D/A converted data.

Address	Variable Name	Description	Details	Remarks
%UXa.b.0~3	_ab_CH0_ERR	CH0 Error	Area to display D/A module operation status (Error)	
	_ab_CH1_ERR	CH1 Error		
	_ab_CH2_ERR	CH2 Error		
	_ab_CH3_ERR	CH3 Error		
%UXa.b.15	_ab_RDY	Module Ready	Area to display D/A module operation status (Module Ready)	Read available
%UXa.b.16~19	_ab_CH0_ACT	CH0~3 Running	Area to save operation information of respective channels	
	_ab_CH1_ACT			
	_ab_CH2_ACT			
	_ab_CH3_ACT			

## 5. Internal Memory Configuration

### 5.1. Configuring internal memory

Address	Variable Name	Description	Details	Remarks
%UXa.b.32~35	_ab_CH0_OUTEN	Output status	Bit On (1) : Output Allowed, Bit Off (0) : Output Disable	
	_ab_CH1_OUTEN			
	_ab_CH2_OUTEN			
	_ab_CH3_OUTEN			
%UWa.b.3	_ab_CH0_DATA	CH0 input value	Area to specify digital data for D/A conversion	Read/Write available
%UWa.b.4	_ab_CH1_DATA	CH1 input value		
%UWa.b.5	_ab_CH2_DATA	CH2 input value		
%UWa.b.6	_ab_CH3_DATA	CH3 input value		

1. In the address assigned, a stands for the Base No. and b for the Slot No. on which the module is installed.
2. In order to read 'CH1 digital value' of D/A conversion module installed on Base No.0, Slot No.4, it should be displayed as %UW0.4.4.

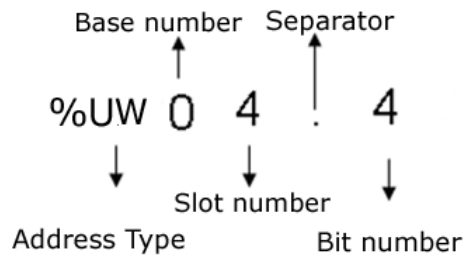



**Setting area of operation parameters**

The following table describes the setting area of D/A conversion module's operation parameters.

Address (Dec.)	Description	Details	Remarks
0	Specify channel to use	Bit On (1): Channel used Bit Off (0): Channel unused	Read/Write available
1	Specify output voltage range	Bit (00): 1~5V, Bit (01) : 0~5V Bit (10): 0~10V, Bit (11) : -10~10V	
	Specify output current range	Bit (00): 4~20mA Bit (01): 0~20mA	
2	Specify input data type	Bit (00): 0~16000, Bit (01): -8000~8000, Bit (10): 0~5000, Bit (11): 0~10000	
3	Specify CH0 output type	"0": outputs the previous value "1": outputs the min. value of output range "2": outputs the mid. value of output range "3": outputs the max. value of output range	
4	Specify CH1 output type		
5	Specify CH2 output type		
6	Specify CH3 output type		
7	-		
8	-		
9	-		
10	-		
11	CH0 setting error	Error code area	
12	CH1 setting error		

## 5. Internal Memory Configuration

### 5.1. Configuring internal memory

Address (Dec.)	Description	Details	Remarks
13	CH2 setting error		
14	CH3 setting error		
15	-		
16	-		
17	-		
18	-		
19	Channel output limit setting	Bit On(1): Enable Bit Off(0): Disable	Read/Write available
20	Ch0 high output limit	-192~16191	
21	Ch0 low output limit		
22	Ch1 high output limit		
23	Ch1 low output limit		
24	Ch2 high output limit		
25	Ch2 low output limit		
26	Ch3 high output limit		
27	Ch3 low output limit		
28	Channel rate control setting		
29	Ch0 increase limit value	0~16000	
30	Ch0 decrease limit value		
31	Ch1 increase limit value		

Address (Dec.)	Description	Details	Remarks
32	Ch1 decrease limit value		
33	Ch2 increase limit value		
34	Ch2 decrease limit value		
35	Ch3 increase limit value		
36	Ch3 decrease limit value		

## 5.2 I/O area of D/A converted data

### Module ready/error (Address 0)

1. **%UXa.b.15:** The D/A module is ON when PLC CPU is powered ON or reset with D/A conversion ready to process D/A conversion.
2. **%UXa.b.0~3:** It is a flag to display the error status of D/A conversion module for respective channels.

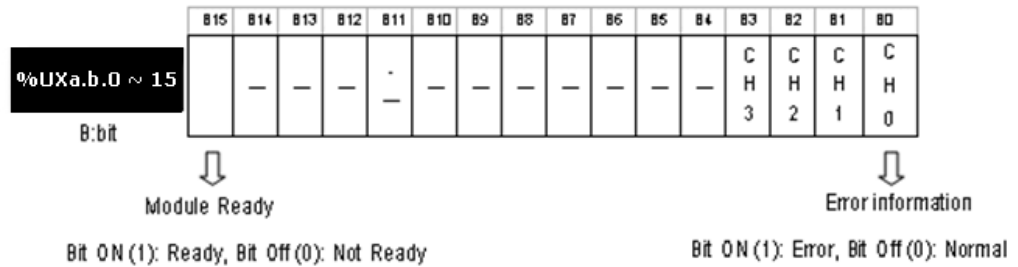

## 5. Internal Memory Configuration

### 5.2. I/O area of D/A converted data

#### Channel operation information (Address 1)

- This area is used to display the channel being used.

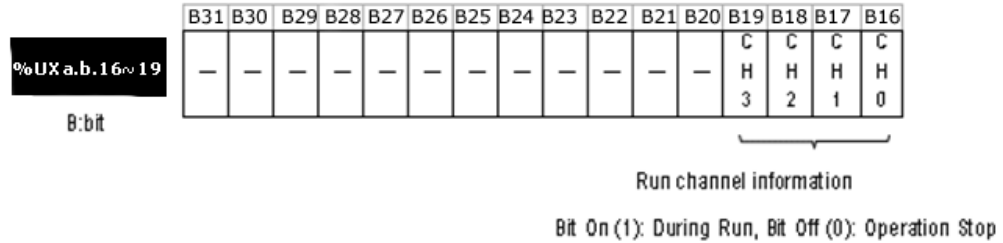

#### Output setting (Address 2)

- Enable/Disable D/A output can be specified for respective channels.
- If the output is not specified, the output of all the channels is disabled.
- Enable/Disable D/A output is as follows:

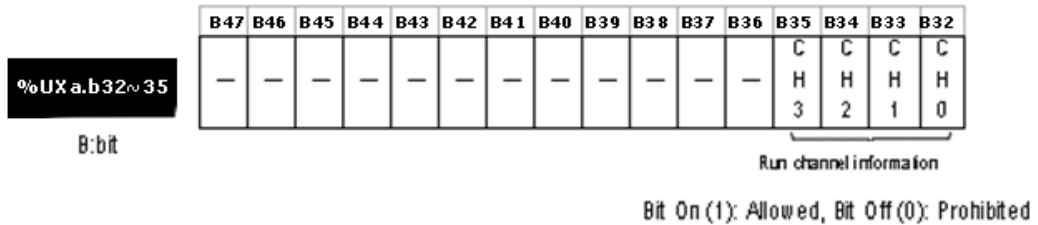

#### Digital input (Address 3~6)

- Based on input type, you can select digital value and use within the range of -192~16191, -8192~8191, 952~5047 or -120~10191 for 1~5V.
- If the digital value is not specified, it is set to 0.

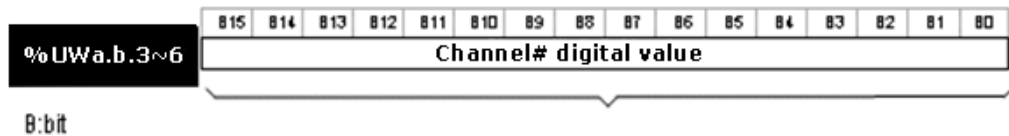

**5. Internal Memory Configuration**  
5.2. I/O area of D/A converted data

---

<b>Address</b>	<b>Details</b>
%UWa.b.3	CH0 digital value
%UWa.b.4	CH1 digital value
%UWa.b.5	CH2 digital value
%UWa.b.6	CH3 digital value

---

## 5.3 Operation parameters settings

### Specifying channels to use

If the channel to use is not specified, all the channels are set to disable.

<b>Address "0"</b>	B15	B14	B13	B12	B11	B10	B9	B8	B7	B6	B5	B4	B3	B2	B1	B0
		-	-	-	-	-	-	-	-	-	-	-	C	C	C	C
B:bit													H	H	H	H
													3	2	1	0

BIT	Details
0	Stop
1	Run

### Setting output voltage/current range

The range of analog output can be specified for respective channels. If the output range is not specified, the range of all the channels is set to 1~5V for voltage output, and 4~20 mA for current output.

The output range is set as follows:

<b>Address "1"</b>	B15	B14	B13	B12	B11	B10	B9	B8	B7	B6	B5	B4	B3	B2	B1	B0
	-	-	-	-	-	-	-	-	C	C	C	C	C	C	C	C
B:bit									H	H	H	H	H	H	H	H
									3	2	1	0	0	0	0	0

BIT	Details
00	1V ~ 5V / 4 ~ 20mA
01	0V ~ 5V / 0 ~ 20mA
10	0V ~ 10V
11	-10V ~ 10V

**Specifying input data type**

Input type can be specified for respective channels. If input type is not specified, all the channels are set to the range of 0~16000.

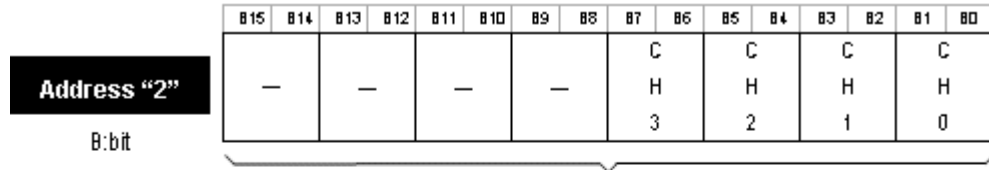

BIT	Details
00	0 ~ 16000
01	-8000 ~ 8000
10	Precise Value
11	0 ~ 10000

This area is used to specify D/A input type for respective channels. The precise value has the digital input ranges as follows:

Analog output	1 ~ 5V	0 ~ 5V	0 ~ 10V	-10 ~ 10V
Digital input				
Precise value	1000~5000	0~5000	0 ~ 10000	-10000 ~ 10000
Analog output	4 ~ 20mA		0 ~ 20mA	
Digital input				
Precise value	4000 ~ 20000		0 ~ 20000	

**5. Internal Memory Configuration**  
**5.3. Operation parameters settings**

**Setting output type**

Based on setting value, the output status is as follows:

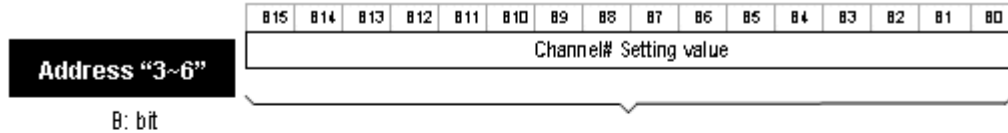

Setting value	Details
0	Keeps the previous value as it is
1	Outputs the minimum value of output range
2	Outputs the middle value of output range
3	Outputs the maximum value of output range

**Error code**

Error codes detected from D/A conversion module are saved.

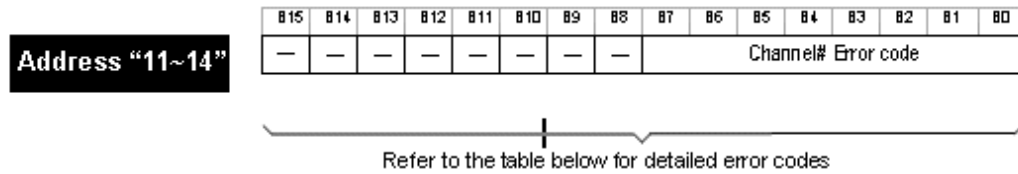

Error Code (Dec)	Description	LED status
10	Module error (Reset Check Error)	Blinks every 0.2s.
11	Module error (Ram Check Error)	
12	Module error (Register Check Error)	
13	Module error (E <sup>2</sup> PROM Check Error)	
21	Module error (D/A Conversion Error)	
31#	Current module's parameters setting error. Refer to Attention.	Blinks every 1s.
32#	Parameters setting error when setting current module's Offset/Gain. Refer to Attention.	
40#	Setting error of current module's digital input range	



**5. Internal Memory Configuration**  
**5.3. Operation parameters settings**

Error Code (Dec)	Description	LED status
	(If input value is set less than -192, or greater than 16191)  The range changes based on input type. Refer to Attention.	
41#	Setting error of voltage module's digital input range (If input value is set less than -192, or greater than 16191)  The range changes based on input type. Refer to Attention.	
50#	Offset/Gain setting error in current module of 4~20mA (If Offset value is set greater than or equal to Gain value). Refer to Attention.	
51#	Offset/Gain setting error in current module of 0~20mA (If Offset value is set greater than or equal to Gain value). Refer to Attention.	
52#	Offset/Gain setting error in voltage module of 1~5V (If Offset value is set greater than or equal to Gain value). Refer to Attention.	
53#	Offset/Gain setting error in voltage module of 0~5V (If Offset value is set greater than or equal to Gain value). Refer to Attention.	
54#	Offset/Gain setting error in voltage module of 0~10V (If Offset value is set greater than or equal to Gain value). Refer to Attention.	
55#	Offset/Gain setting error in voltage module of -10~10V (#: channel)  (If Offset value is set greater than or equal to Gain value). Refer to Attention.	

**5. Internal Memory Configuration**  
**5.3. Operation parameters settings**

---



**ATTENTION**

# (0~3) stands for the channel with error found.

---

**Output limit setting**

When the output limit setting is not used, all channels are set to **Disable**.

<b>Address "19"</b>	B15	B14	B13	B12	B11	B10	B9	B8	B7	B6	B5	B4	B3	B2	B1	B0
	-	-	-	-	-	-	-	-	-	-	-	-	C	C	C	C
B:bit													H	H	H	H
													3	2	1	0

BIT	Description
0	Disable
1	Enable

**CH0 high output limit setting**

Step	Action
1	The value of high output limit can be set when output limit setting is set to 'Enable'.
2	The value of high output limit can be set within -192~16191.
3	The value of high output limit must be more than the value of low output limit.

<b>Address "19"</b>	B15	B14	B13	B12	B11	B10	B9	B8	B7	B6	B5	B4	B3	B2	B1	B0
	CH# High/Low output limit															
B:bit																

  

Address	Description
20	CH0 High output limit
21	CH0 Low output limit

---

**Rate control setting**

All channels are set to **Disable** when rate control setting is not set.

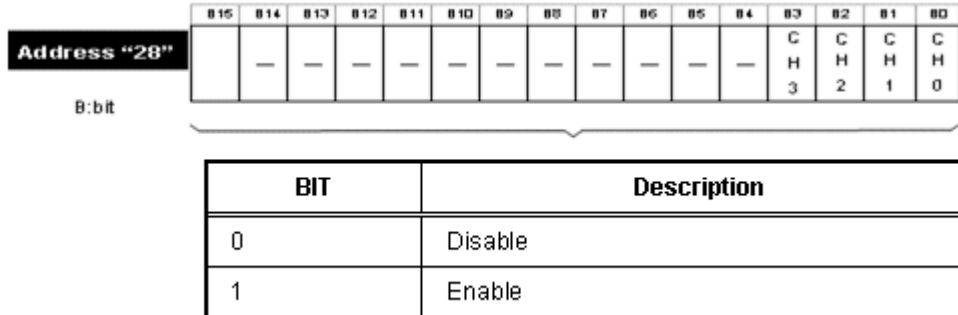

**CH0 increase limit value setting**

- | Step | Action  |
|------|---|
| 1    | Increase limit value can be set when rate control setting is set to <b>Enable</b> . |
| 2    | Increase limit value can be set within 0~16000.                                     |

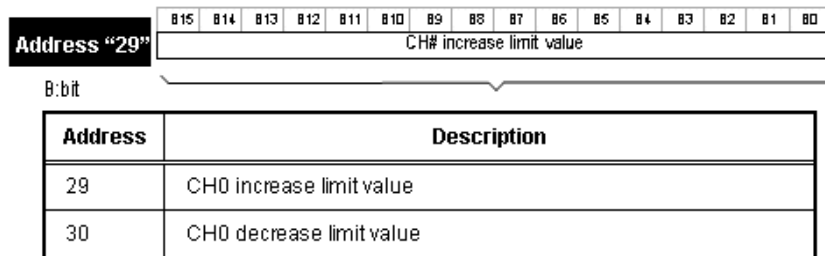

## **5. Internal Memory Configuration**

### **5.3. Operation parameters settings**

---

## 6. Programming

### 6.1 Internal memory read/write

#### Reading internal memory (GET, GETP instruction)

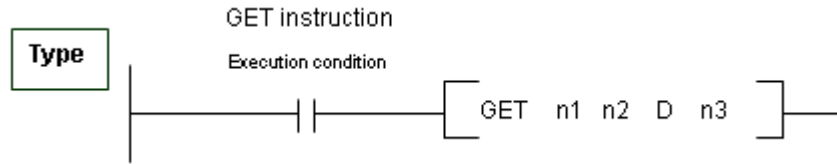

Type	Description	Area available
n1	Slot No. the special module is installed on	Integer
n2	Start address of special module's internal memory to read data	Integer
D	Device's start address with saved data to read	M, P, K, L, T, C, D, #D
n3	Number of words data to read	Integer

#### Difference between GET instruction and GETP instruction

- **GET**: always executed with execution condition On ( )
- **GETP**: executed with execution condition of operation start ( )

**Example:** If D/A conversion module is installed on base No.0 and slot No.3, and internal memory address No.0 and 1's data in D/A conversion module is read to D16 and D17 of CPU module.

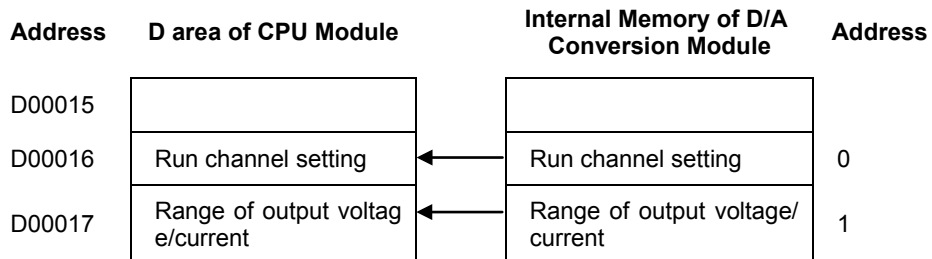

## 6. Programming

### 6.1. Internal memory read/write

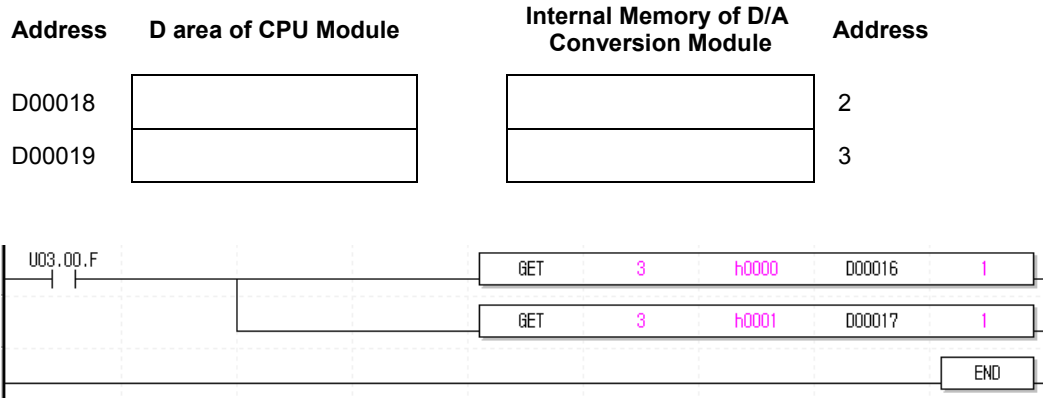

### Write of internal memory (PUT, PUTP instruction)

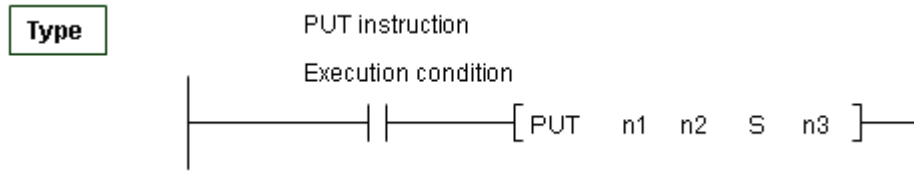

Type	Description	Area available
<b>n1</b>	Slot No. the special module is installed on	Integer
<b>n2</b>	Start address of special module's internal memory to write data.	Integer
<b>S</b>	Device's start address or integer with saved data to write.	M, P, K, L, T, C, D, #D, Integer
<b>n3</b>	Number of words data to write	Integer

### Difference between PUT instruction and PUTP instruction

- **PUT**: It is always executed with execution condition On ( )
- **PUTP**: It is executed with execution condition of operation start ( )

**Example:** If D/A conversion module is installed on Base No.0 and Slot No.6, and CPU module's data of D16~D17 is written on internal memory addresses 0~1 of D/A conversion module.

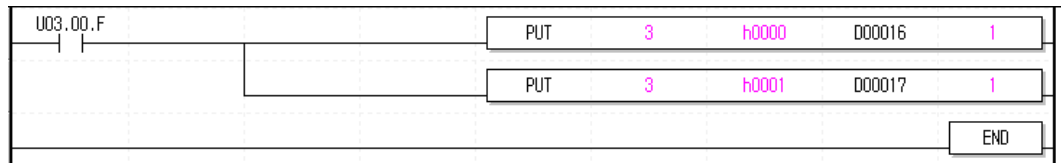
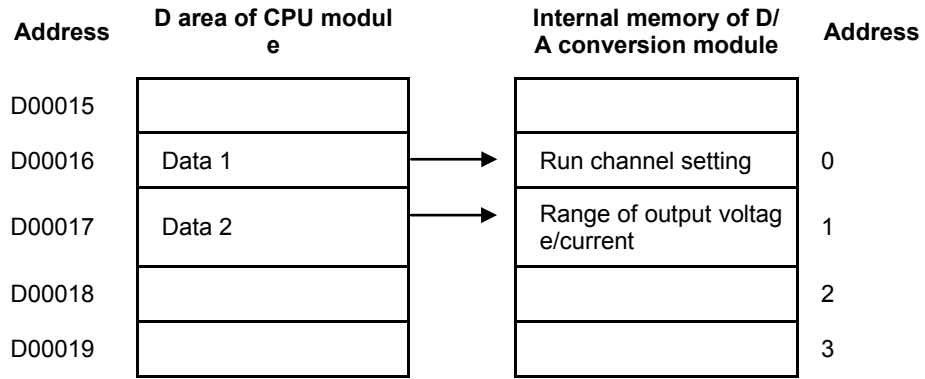

## 6.2 Basic program

### System configuration

Basic program configuration consists of specifying the Run condition details of D/A conversion module's internal memory. D/A conversion module is installed on slot 1. I/O assigned points of D/A conversion module is 16 points.

2MLP-ACF1	2MLK-CPUH		2MLF-DC4S RUN ALM		

### 2MLF-DC4S

Step	Action
1	Program example through I/O parameter setting.

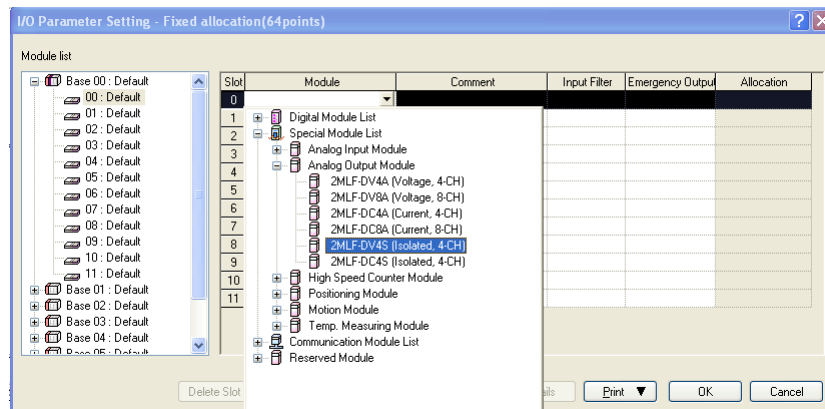



**Step** **Action**

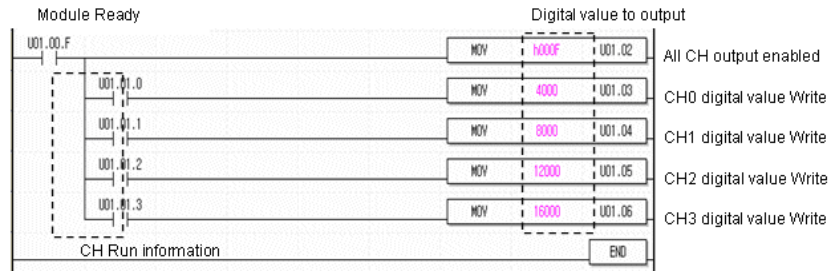
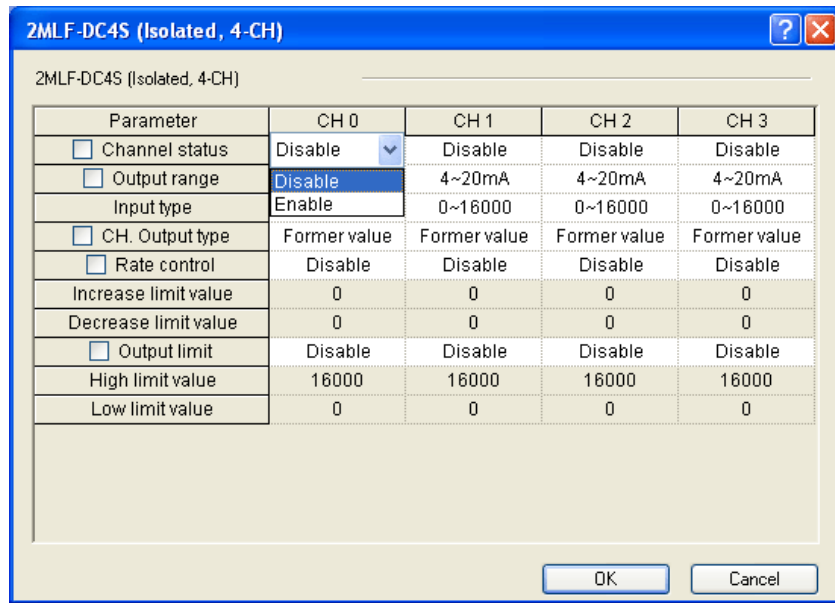

Program example with PUT/GET instruction used.

**6. Programming**  
**6.2. Basic program**

**Step** **Action**

Step	Action	Slot No.	Internal Memory address	Setting data	The number of data to write	Description
U01.00.F	PUT	1	0	1000F	1	Used CH(CH0.1.2.3)
Module Ready	PUT	1	1	0	1	Output range(4~20mA)
	PUT	1	2	0	1	Data type (0~16000)
	PUT	1	3	0	4	CH output status setting 0,1,2,3: Output previous value
	M00000	MOV	1000F	U01.02		All CH output allowed
CH operation contact	MOV	U01.01.0	4000	U01.03		CH0 digital value Write
	MOV	U01.01.1	8000	U01.04		CH1 digital value Write
	MOV	U01.01.2	12000	U01.05		CH2 digital value Write
	MOV	U01.01.3	16000	U01.06		CH3 digital value Write
CH Run information	END					

## 6.3 Application program

### Inverter speed control

#### System configuration

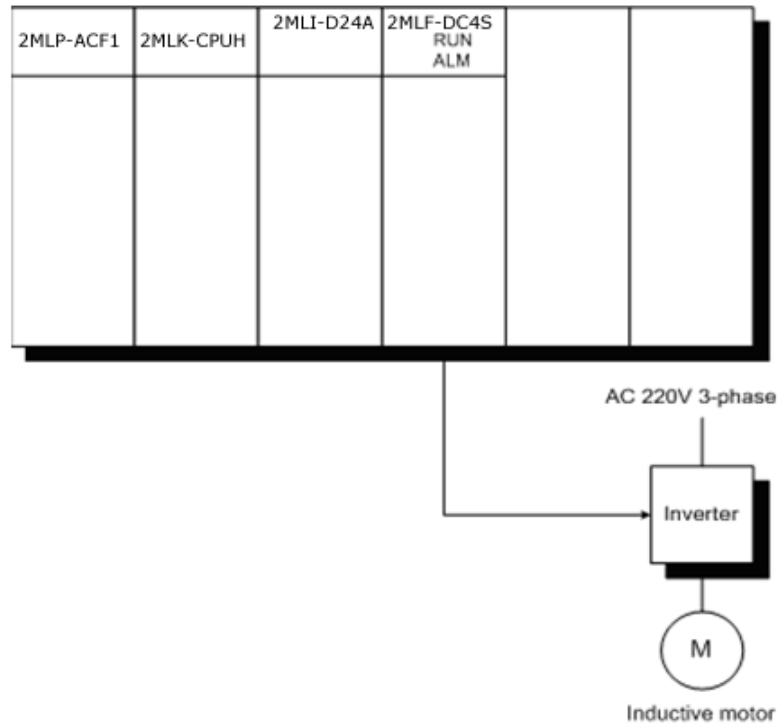

#### Details of initial setting

No	Parameters	Setting Details	Internal Memory Address
1	Channels	CH 0	0
2	Output voltage range	0 ~ 20mA	1
3	Data type	0 ~ 16000	2
4	Channel output type	Previous value	3

## 6. Programming

### 6.3. Application program

#### Description of program

- At the same time Module Ready Contact is ON, output of all the channels is set to Allowed.
- If P0001 is On, 0mA is output.
- If P0002 is Off and P0002 is On, 5mA is output.
- If P0003 is Off and P0003 is On, 10mA is output.
- If P0004 is Off and P0004 is On, 15mA is output.

#### Program

- a) Program example through I/O Parameters Setting.

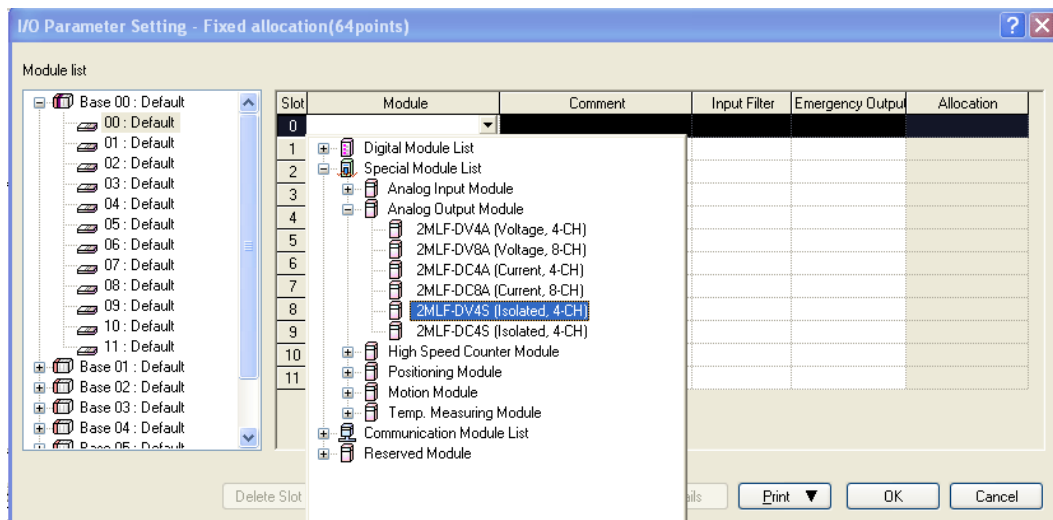

**6. Programming**  
**6.3. Application program**

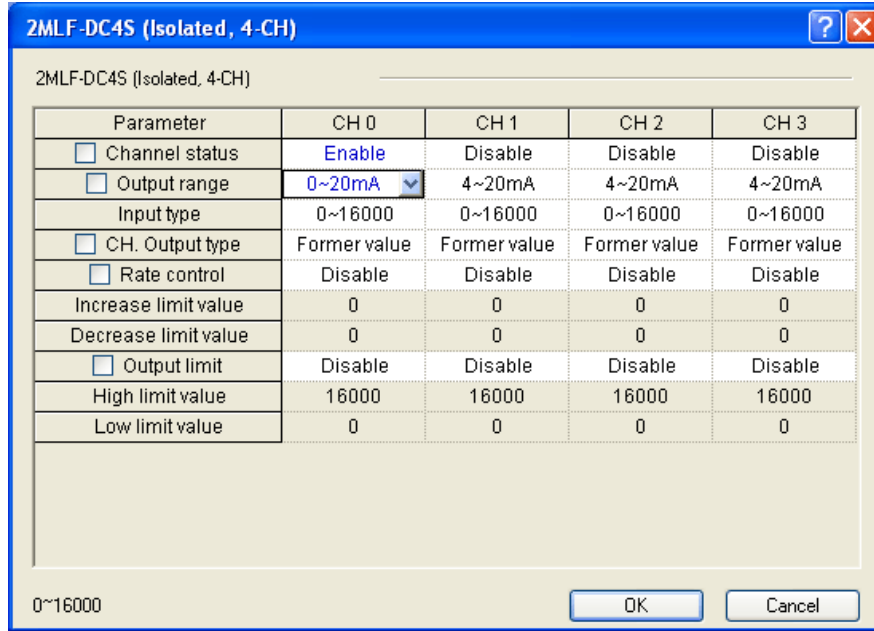

b) Program

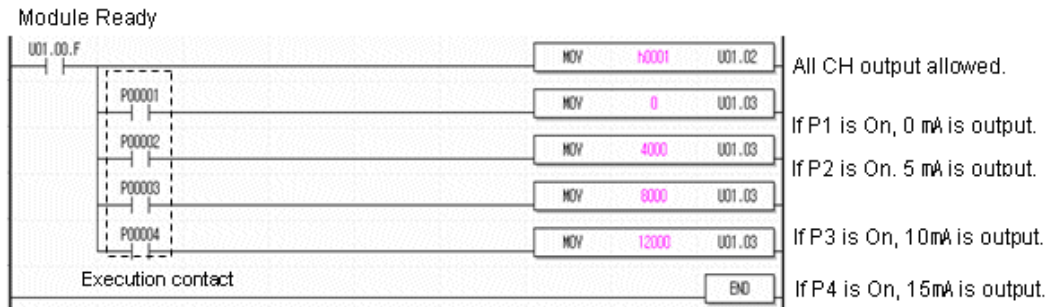

**6. Programming**  
**6.3. Application program**

c) Program example with PUT/GET instruction used.

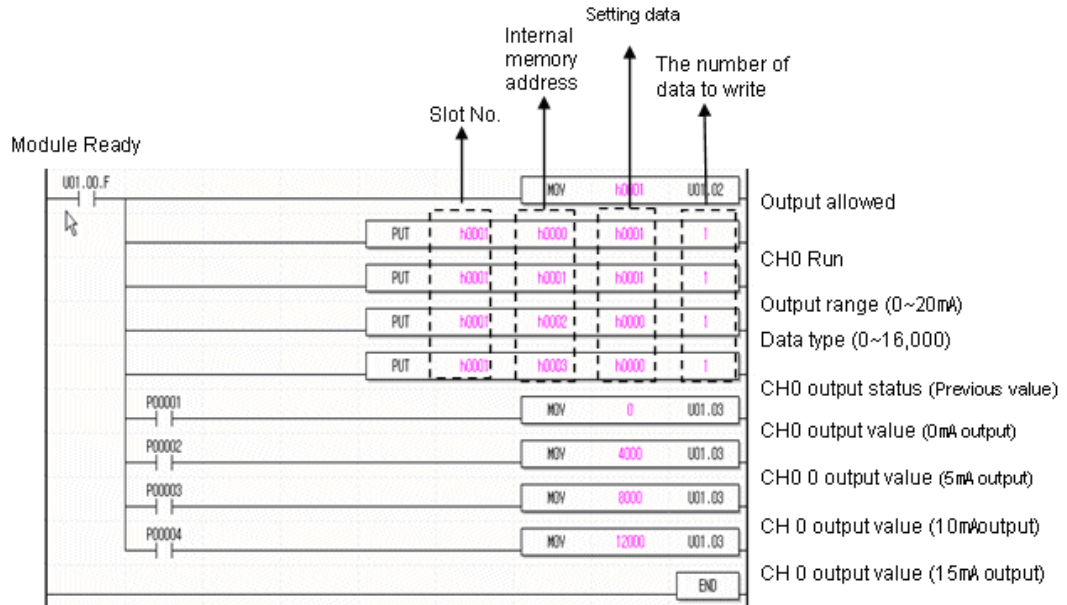

**BCD output of error code**

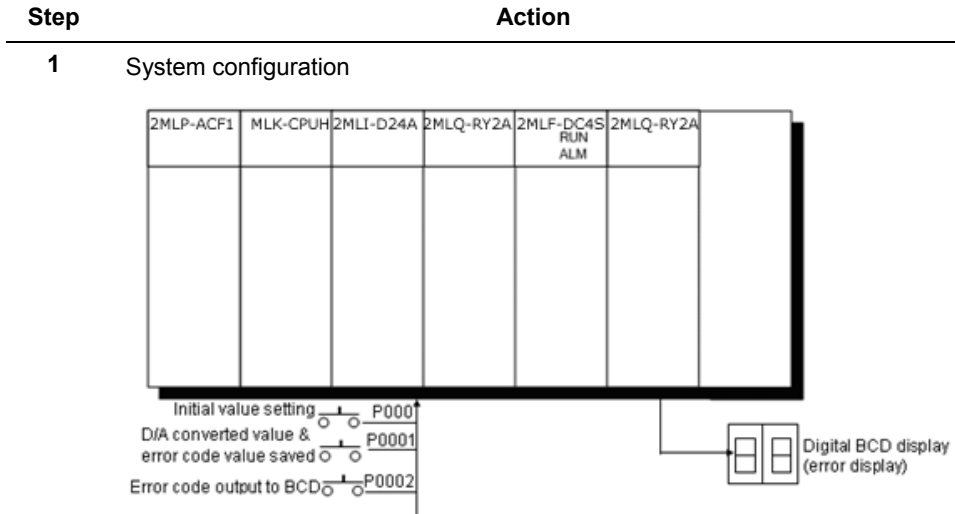

Step	Action
2	Details of initial setting <ul style="list-style-type: none"><li>a) Used CH: CH 0</li><li>b) Analog output current range: DC 4 ~ 20mA</li><li>c) Digital input data range: 0 ~ 16000</li></ul>
3	Description of program <ul style="list-style-type: none"><li>a) If P00000 is ON, D/A conversion is initially specified.</li><li>b) If P00001 is ON, D/A converted value and error code are saved, respectively, on D00000 and D00001.</li><li>c) If P00002 is ON, applicable error code is output to digital BCD display (P00040 ~ P0004F).</li></ul>

---

## 6. Programming

### 6.3. Application program

Step	Action
------	--------

4	Program
---	---------

a) Program example through I/O Parameter setting.

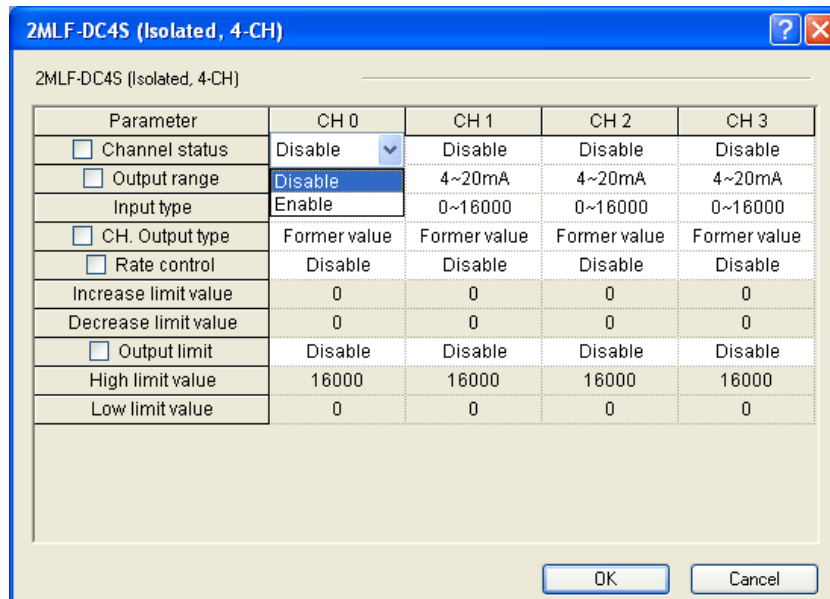

Module READY

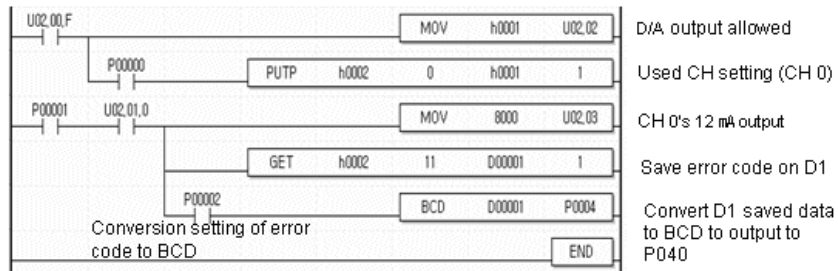

b) Program example with PUT/GET instruction used.



**6. Programming**  
**6.3. Application program**

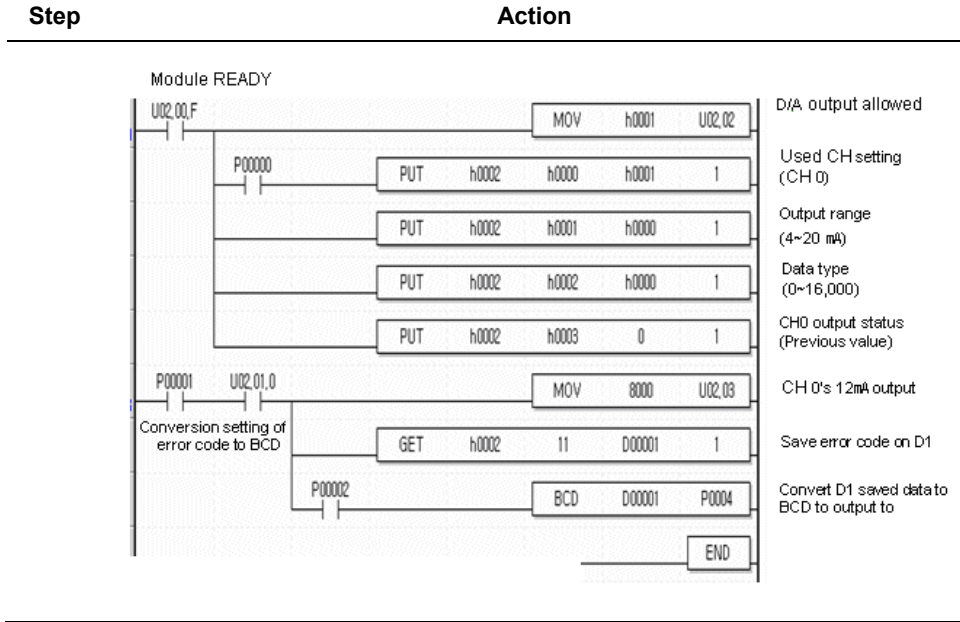

## **6. Programming**

### 6.3. Application program

---

## 7. Troubleshooting

### 7.1 Diagnosing errors

#### Error codes

The following table describes the details and diagnosis of errors which occur while D/A conversion module.

Error Code (Dec)	Description	LED status
10	Module error (Reset Check Error)	Blinks every 0.2s.
11	Module error (RAM Check Error)	
12	Module error (Register Check Error)	
13	Module error (E <sup>2</sup> PROM Check Error)	
21	Module error (D/A Conversion Error)	
31	Parameters setting error of current module. Refer to Attention.	Blinks every 1s.
32	Parameters setting error of current module when setting Offset/Gain. Refer to Attention.	
40	Setting error of current module's digital input range (If input value is set less than -192 or greater than 16191). The range changes based on input data type. Refer to Attention.	
41#	Setting error of voltage module's digital input range (If input value is set less than -192 or greater than 16191). The range changes based on input data type. Refer to Attention.	
50#	Offset/Gain setting error in current module of 4~20mA (Offset value is set greater than or equal to Gain value). Refer to Attention.	
51#	Offset/Gain setting error in current module of 0~20mA (Offset value is set greater than or equal to Gain value). Refer to Attention.	
52#	Offset/Gain setting error in voltage module of 1~5V. Refer to Attention.  (Offset value is set greater than or equal to Gain value)	

## 7. Troubleshooting

### 7.1 Diagnosing errors. Diagnosing errors Diagnosing errors

Error Code (Dec)	Description	LED status
53#	Offset/Gain setting error in voltage module of 0~5V (Offset value is set greater than or equal to Gain value). Refer to Attention.	
54#	Offset/Gain setting error in voltage module of 0~10V (Offset value is set greater than or equal to Gain value). Refer to Attention.	
55#	Offset/Gain setting error in voltage module of -10~10V (Offset value is set greater than or equal to Gain value). Refer to Attention.	



#### ATTENTION

- # of the error code stands for the channel with error found.
- If 2 or more errors occur, the module will not save other error codes than the first error code found.

If errors occur:

Error Code	Module Ready	Error Bit Status	Error Code	LED
10, 11, 12, 13, 21	Deleted (OFF)	Set all the channels	Displayed on system area	Blinks every 0.2s.
31#, 40#, 41#, 60#	Kept	Set applicable channel only	Displayed on system area	Blinks every 1s
32#, 50#, 51#, 52#, 53#, 54#, 55#	Kept	-	Offset/Gain error code area	Blinks every 1s

If errors are deleted:

<b>Error Code</b>	<b>Module Ready</b>	<b>Error Bit Status</b>	<b>Error Code</b>	<b>LED</b>
10, 11, 12, 13, 21	Power On/Off	-	-	-
31#, 40#, 41#, 60#	Kept	Clear	Clear	On
32#, 50#, 51#, 52#, 53#, 54#, 55#	Kept	-	Clear	On

## 7. Troubleshooting

### 7.1 Diagnosing errors. Diagnosis of errors

---

## 7.2 Diagnosis of errors

### RUN LED blinks

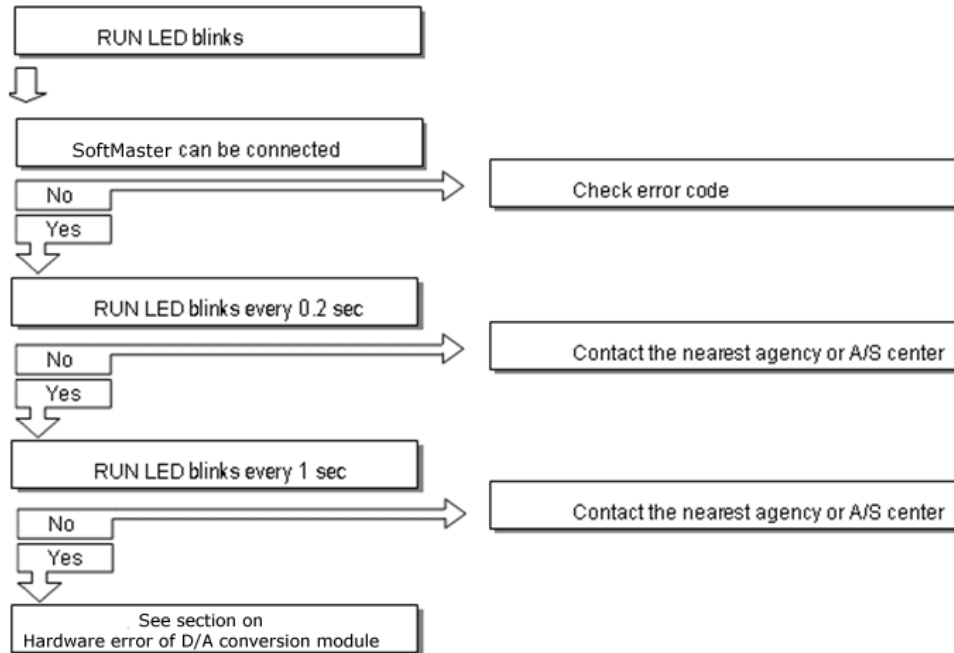

**RUN LED is Off**

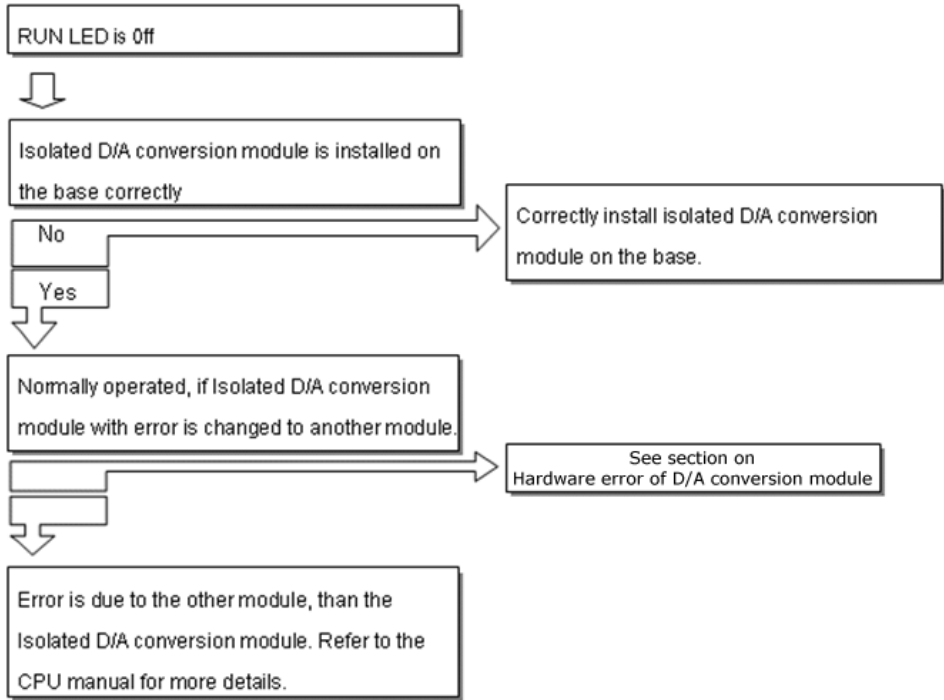

## 7. Troubleshooting

### 7.1 Diagnosing errors. Diagnosis of errors

---

#### D/A output value hunted too much

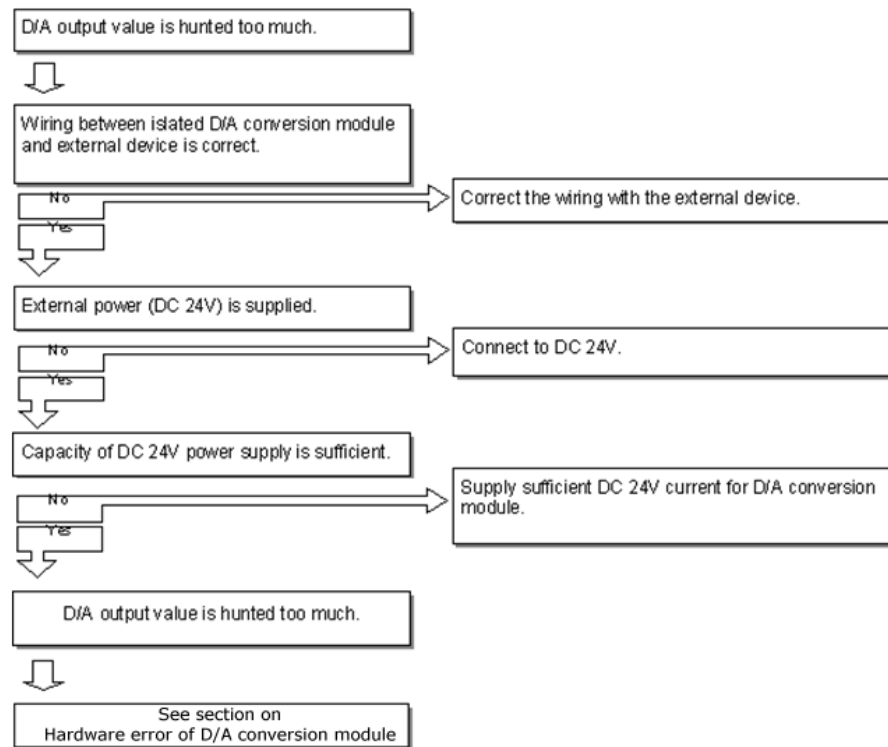



**Relationship discordant between digital value and analog output value**

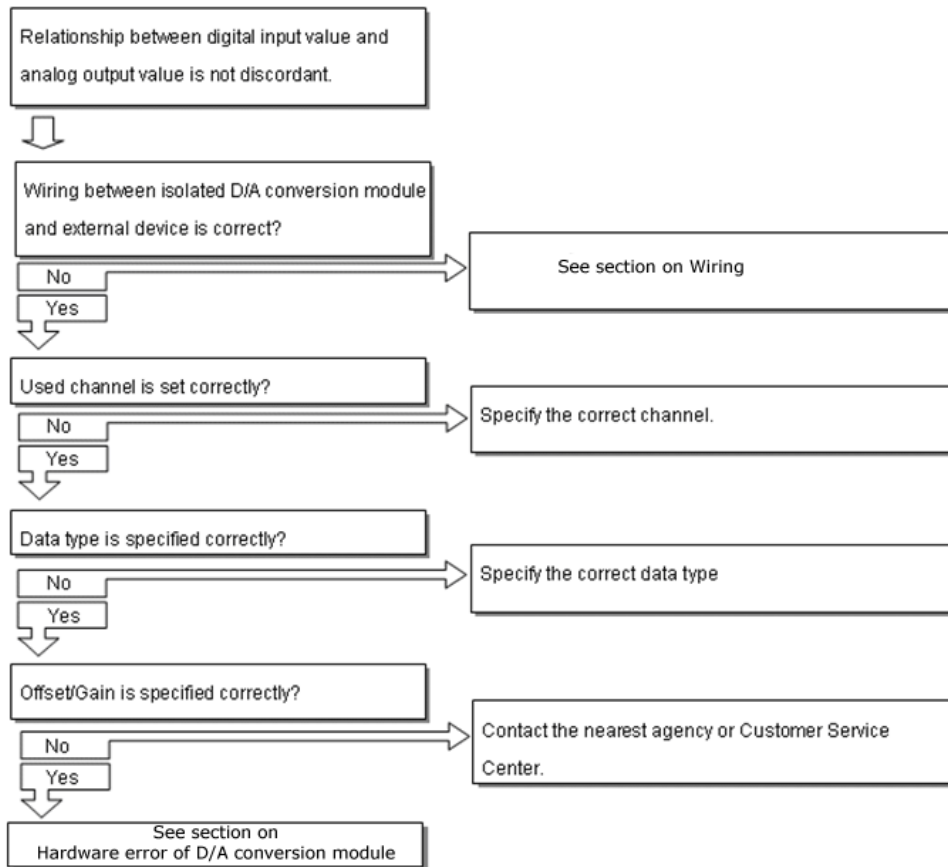

## 7. Troubleshooting

### 7.1 Diagnosing errors. Diagnosis of errors

---

#### D/A output value always exceeds the value specified

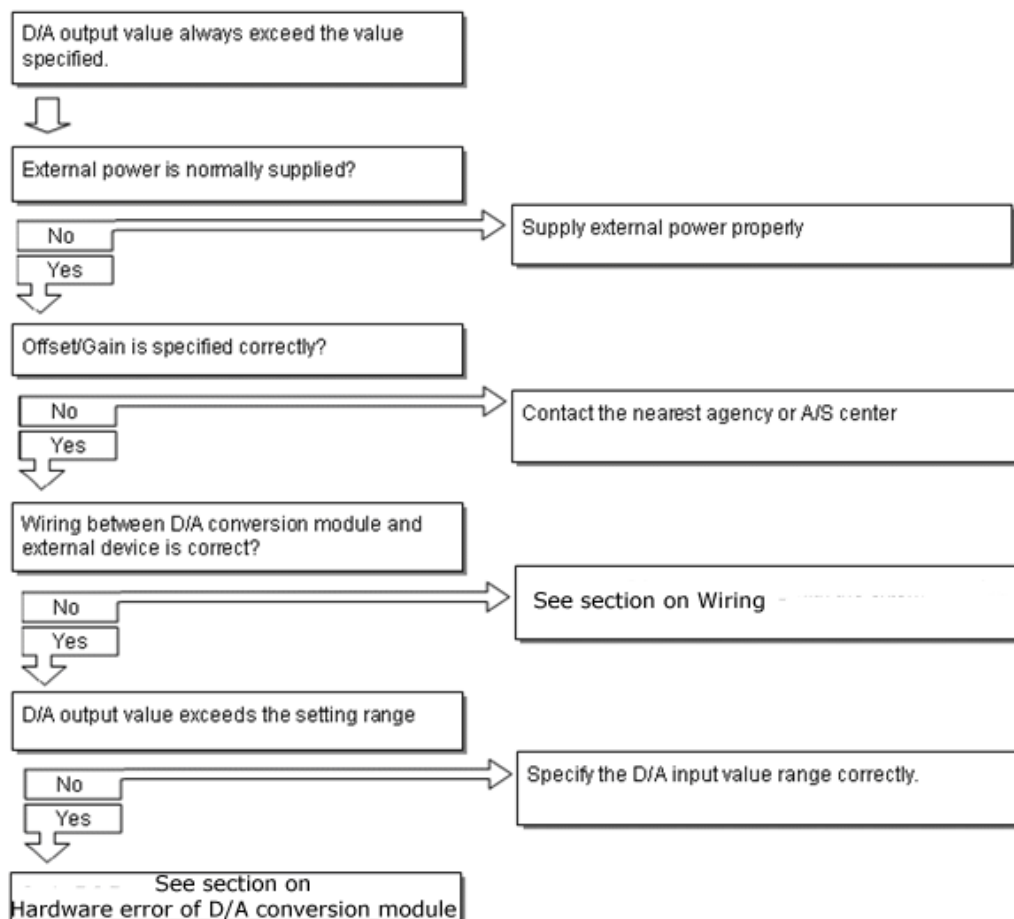

**Analog output value does not change according to the change of digital value**

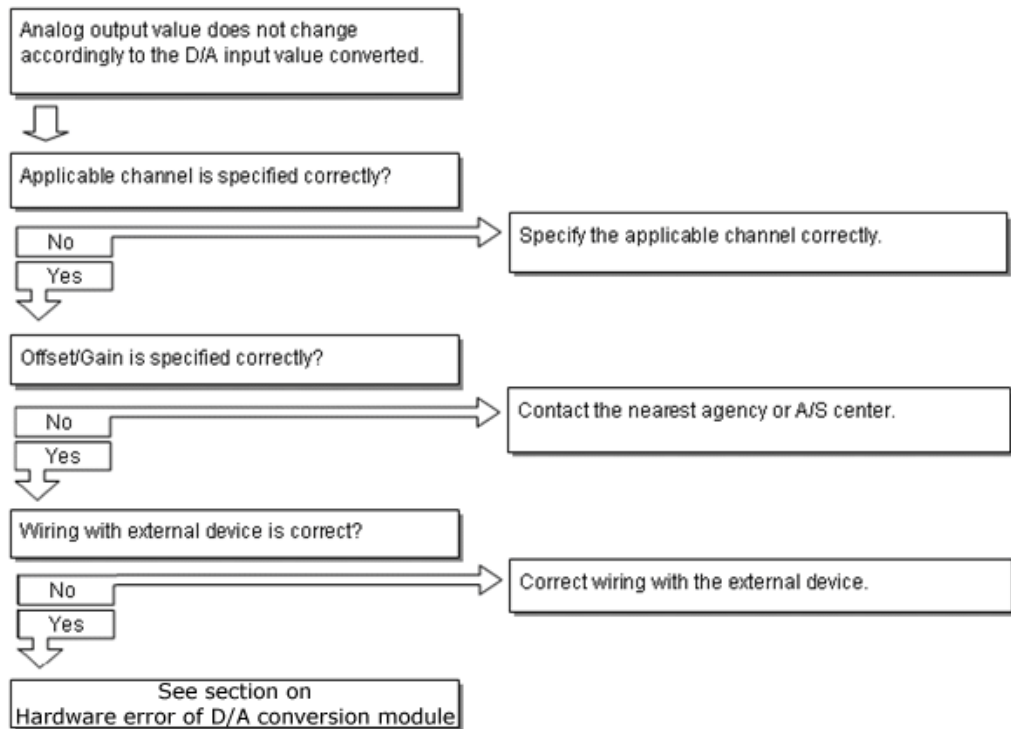

**Hardware error of D/A conversion module**

It is D/A conversion module's Hardware error.  
Contact the nearest Customer Service Center.  
CH2 Output

## 7. Troubleshooting

### 7.1 Diagnosing errors. Diagnosis of errors

---

#### Status check of D/A conversion module through SoftMaster system monitoring

Module type, module information, O/S version and module status of D/A conversion module can be checked through SoftMaster system monitoring function.

Step	Action
<b>1</b>	<b>Execution sequence</b> <ul style="list-style-type: none"><li>a) From the <b>Monitor</b> menu, select <b>System Monitoring</b>.</li><li>b) On the module window, right-click the module and select <b>Module &gt; Module Info</b> from the context menu. Or<ul style="list-style-type: none"><li>a) From the <b>Monitor</b> menu, select <b>System Monitoring</b>.</li><li>b) Double-click the module window.</li></ul></li></ul> <p>Two routes are available for the execution.</p>
<b>2</b>	<b>Module Information</b> <ul style="list-style-type: none"><li>a) <b>Module type</b>: shows the information of the module currently installed.</li><li>b) <b>Module information</b>: shows the O/S version information of D/A conversion module.</li><li>c) <b>O/S version</b>: shows the O/S prepared date of D/A conversion module.</li><li>d) <b>Module status</b>: shows the present error code.</li></ul>

Step	Action
3	System Monitor

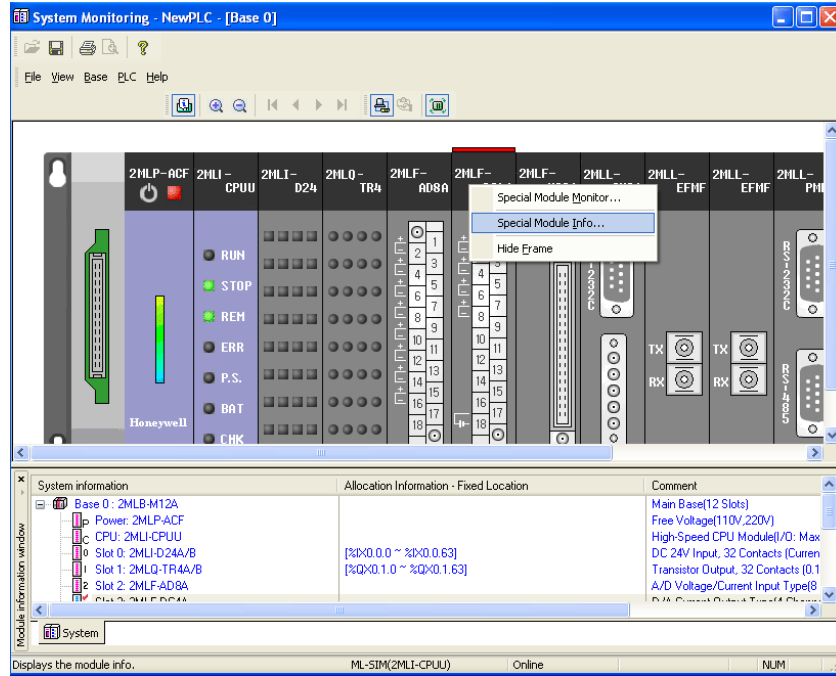

## **7. Troubleshooting**

### **7.1 Diagnosing errors. Diagnosis of errors**

---

## 8. Appendix 1

### 8.1 Dimensions of 2MLF-DV4S/DC4S

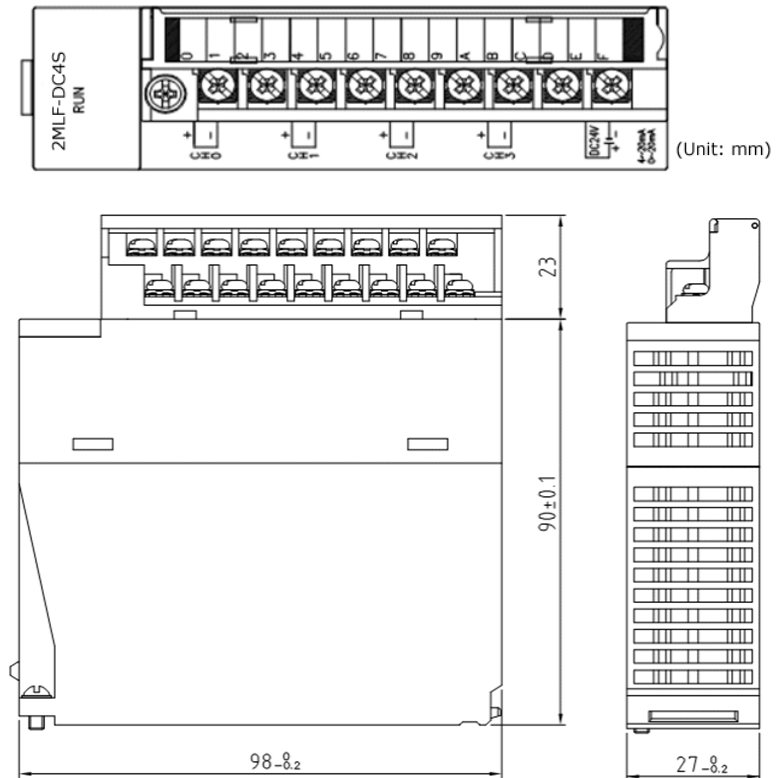

**Honeywell**

---

Honeywell Process Solutions  
1860 W. Rose Garden Lane  
Phoenix, AZ 85027 USA